

PP

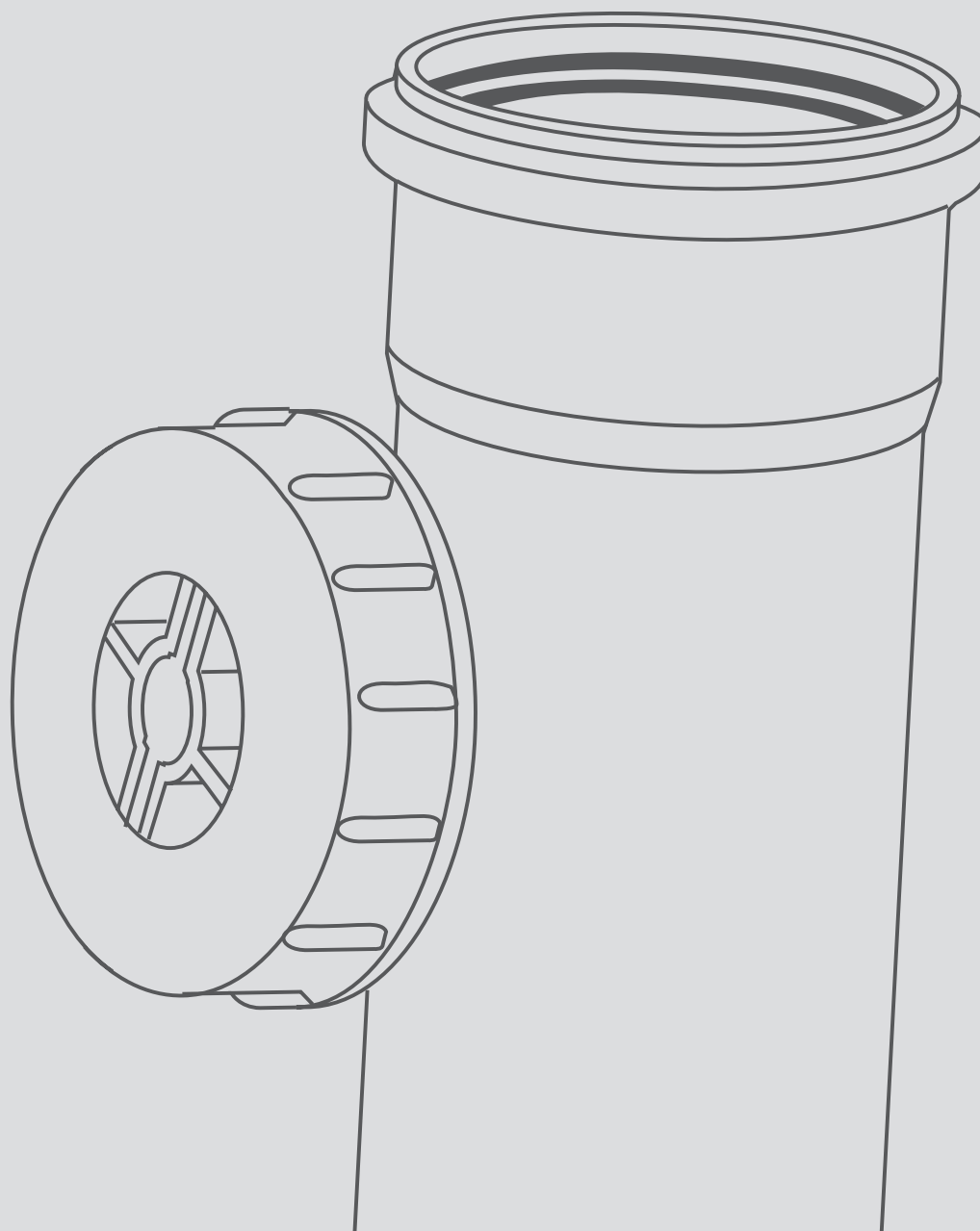

HT odpadní systémy z polypropylenu



MADE IN ITALY

BOHEMIA
GENOVA

www.genovaboheemia.cz





05/2014



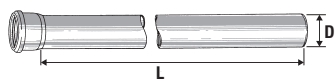

ceník v CZK
uvedené ceny jsou bez DPH (21%)

valsir[®]
QUALITY FOR PLUMBING

HTEM HT trubky s hrdlem



COD.	CL	D	DN	L (mm)				HxLxP 	Kč/ks
VS0500001	PP01	32	30	150	30	240	1440	970x800x1200	22
VS0500003	PP01	32	30	250	30	240	1440	970x800x1200	25
VS0500005	PP01	32	30	500	30	180	900	905x800x1200	37
VS0500007	PP01	32	30	750	30	-	-	-	51
VS0500009	PP01	32	30	1000	30	-	-	-	59
VS0500011	PP01	32	30	1500	30	-	-	-	81
VS0500013	PP01	32	30	2000	30	-	-	-	123
VS0500015	PP01	32	30	3000	30	-	-	-	175
VS0500021	PP01	40	40	150	30	240	1200	1030x800x1200	22
VS0500023	PP01	40	40	250	30	240	960	1010x800x1200	25
VS0500025	PP01	40	40	500	50	200	600	970x800x1200	31
VS0500027	PP01	40	40	750	30	120	360	880x800x1200	42
VS0500029	PP01	40	40	1000	30	-	-	-	47
VS0500031	PP01	40	40	1500	30	-	-	-	81
VS0500033	PP01	40	40	2000	30	-	-	-	93
VS0500035	PP01	40	40	3000	30	-	-	-	162
VS0500041	PP01	50	50	150	30	240	960	1010x800x1200	24
VS0500043	PP01	50	50	250	30	240	720	1015x800x1200	29
VS0500045	PP01	50	50	500	35	140	420	970x800x1200	38
VS0500047	PP01	50	50	750	30	-	-	-	57
VS050004702	PP01	50	50	750	260	-	-	-	57
VS0500049	PP01	50	50	1000	30	-	-	-	61
VS050004902	PP01	50	50	1000	260	-	-	-	61
VS0500051	PP01	50	50	1500	30	-	-	-	99
VS050005102	PP01	50	50	1500	260	-	-	-	99
VS0500053	PP01	50	50	2000	30	-	-	-	119
VS050005302	PP01	50	50	2000	260	-	-	-	119
VS0500055	PP01	50	50	3000	30	-	-	-	230
VS0500061	PP01	75	70	150	30	240	480	1050x800x1200	43
VS0500063	PP01	75	70	250	20	160	320	1050x800x1200	48
VS0500065	PP01	75	70	500	20	80	240	1075x800x1200	68
VS0500067	PP01	75	70	750	25	-	-	-	84
VS050006702	PP01	75	70	750	120	-	-	-	84
VS0500069	PP01	75	70	1000	25	-	-	-	99
VS050006902	PP01	75	70	1000	120	-	-	-	99
VS0500071	PP01	75	70	1500	25	-	-	-	146
VS050007102	PP01	75	70	1500	120	-	-	-	146
VS0500073	PP01	75	70	2000	25	-	-	-	176

COD.	CL	D	DN	L (mm)				HxLxP 	Kč/ks
VS050007302	PP01	75	70	2000	120	-	-	-	176
VS0500075	PP01	75	70	3000	25	-	-	-	294
VS0599001	PP01	90	90	150	24	96	384	1050x800x1200	57
VS0599003	PP01	90	90	250	24	96	288	1165x800x1200	60
VS0599005	PP01	90	90	500	24	96	192	1300x800x1200	87
VS0599009	PP01	90	90	1000	20	-	-	-	134
VS059900902	PP01	90	90	1000	96	-	-	-	134
VS0599011	PP01	90	90	1500	20	-	-	-	236
VS0599013	PP01	90	90	2000	20	-	-	-	262
VS059901302	PP01	90	90	2000	96	-	-	-	262
VS0599015	PP01	90	90	3000	20	-	-	-	407
VS0500081	PP01	110	100	150	15	60	240	1050x800x1200	65
VS0500083	PP01	110	100	250	15	60	180	1165x800x1200	73
VS0500085	PP01	110	100	500	15	60	120	1300x800x1200	119
VS0500087	PP01	110	100	750	15	-	-	-	151
VS050008702	PP01	110	100	750	80	-	-	-	151
VS0500089	PP01	110	100	1000	15	-	-	-	184
VS050008902	PP01	110	100	1000	80	-	-	-	184
VS0500091	PP01	110	100	1500	15	-	-	-	284
VS050009102	PP01	110	100	1500	80	-	-	-	284
VS0500093	PP01	110	100	2000	15	-	-	-	340
VS050009302	PP01	110	100	2000	80	-	-	-	340
VS0500095	PP01	110	100	3000	15	-	-	-	551
VS0500101	PP01	125	125	150	10	80	160	1050x800x1200	93
VS0500103	PP01	125	125	250	10	40	120	1165x800x1200	116
VS0500105	PP01	125	125	500	6	48	96	1340x800x1200	163
VS0500107	PP01	125	125	750	8	-	-	-	203
VS0500109	PP01	125	125	1000	10	-	-	-	268
VS0500111	PP01	125	125	1500	10	-	-	-	321
VS0500113	PP01	125	125	2000	10	-	-	-	412
VS0500115	PP01	125	125	3000	10	-	-	-	704
VS0500121	PP01	160	150	150	10	-	-	-	181
VS0500123	PP01	160	150	250	10	-	-	-	218
VS0500125	PP01	160	150	500	10	-	-	-	330
VS0500129	PP01	160	150	1000	10	-	-	-	471
VS0500131	PP01	160	150	1500	10	-	-	-	596
VS0500133	PP01	160	150	2000	10	-	-	-	757
VS0500135	PP01	160	150	3000	10	-	-	-	1075



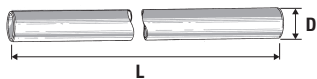

HTGL HT trubky bez hrdla



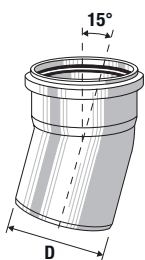



COD.	CL	D	DN	L (mm)		Kč/ks
VS0500019	PP01	32	30	5000	50	254
VS0500039	PP01	40	40	5000	50	211
VS0500059	PP01	50	50	5000	50	263
VS0500079	PP01	75	70	5000	30	383
VS050007902	PP01	75	70	5000	105	383
VS0599019	PP01	90	90	5000	20	560
VS0500099	PP01	110	100	5000	15	737
VS050009902	PP01	110	100	5000	100	737
VS0500119	PP01	125	125	5000	10	1118

HTB HT koleno





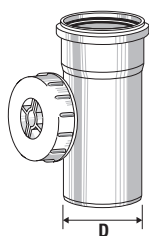

COD.	CL	D	DN	α				HxLxP 	Kč/ks
VS0504001	PP02	32	30	15°	80	640	3840	970x800x1200	22
VS0504003	PP02	32	30	30°	80	640	3840	970x800x1200	22
VS0504005	PP02	32	30	45°	80	640	2560	850x800x1200	22
VS0504007	PP02	32	30	67°30'	60	480	2880	970x800x1200	22
VS0504009	PP02	32	30	80°	60	480	2880	970x800x1200	24
VS0504011	PP02	32	30	87°30'	60	480	2880	970x800x1200	22
VS0504013	PP02	40	40	15°	50	400	1600	850x800x1200	17
VS0504015	PP02	40	40	30°	50	400	1600	850x800x1200	17
VS0504017	PP02	40	40	45°	50	400	1600	850x800x1200	17
VS0504019	PP02	40	40	67°30'	50	400	1600	1010x800x1200	18
VS0504021	PP02	40	40	80°	50	400	1600	1010x800x1200	20
VS0504023	PP02	40	40	87°30'	50	400	1600	1010x800x1200	18
VS0504025	PP02	50	50	15°	30	240	960	850x800x1200	19
VS0504027	PP02	50	50	30°	30	240	960	850x800x1200	19
VS0504029	PP02	50	50	45°	30	240	960	850x800x1200	19
VS0504031	PP02	50	50	67°30'	30	240	960	850x800x1200	20
VS0504033	PP02	50	50	80°	30	240	960	850x800x1200	23
VS0504035	PP02	50	50	87°30'	30	240	960	850x800x1200	20
VS0504037	PP02	75	70	15°	20	160	640	1010x800x1200	32
VS0504039	PP02	75	70	30°	20	160	640	1010x800x1200	32
VS0504041	PP02	75	70	45°	20	160	480	1015x800x1200	32
VS0504043	PP02	75	70	67°30'	20	160	480	1015x800x1200	34

COD.	CL	D	DN	α				HxLxP 	Kč/ks
VS0504045	PP02	75	70	80°	20	160	480	1015x800x1200	40
VS0504047	PP02	75	70	87°30'	20	160	480	1015x800x1200	34
VS0599041	PP02	90	90	15°	20	160	480	1015x800x1200	41
VS0599043	PP02	90	90	30°	20	160	320	1050x800x1200	41
VS0599045	PP02	90	90	45°	20	80	240	853x800x1200	41
VS0599047	PP02	90	90	67°30'	20	80	240	853x800x1200	42
VS0599051	PP02	90	90	87°30'	20	80	240	853x800x1200	42
VS0504049	PP02	110	100	15°	20	80	240	970x800x1200	47
VS0504051	PP02	110	100	30°	20	80	240	970x800x1200	47
VS0504053	PP02	110	100	45°	20	80	240	1039x800x1200	47
VS0504055	PP02	110	100	67°30'	20	80	160	940x800x1200	48
VS0504057	PP02	110	100	80°	20	80	160	940x800x1200	54
VS0504059	PP02	110	100	87°30'	20	80	160	940x800x1200	48
VS0504061	PP02	125	125	15°	20	80	160	940x800x1200	158
VS0504063	PP02	125	125	30°	20	80	160	940x800x1200	158
VS0504065	PP02	125	125	45°	15	60	120	940x800x1200	158
VS0504067	PP02	125	125	67°30'	15	60	120	940x800x1200	166
VS0504069	PP02	125	125	80°	15	60	120	940x800x1200	170
VS0504071	PP02	125	125	87°30'	10	40	120	1039x800x1200	166
VS0504073	PP02	160	150	15°	10	40	80	940x800x1200	232
VS0504075	PP02	160	150	30°	10	40	80	940x800x1200	232
VS0504077	PP02	160	150	45°	10	40	80	940x800x1200	244
VS0504083	PP02	160	150	87°30'	10	40	80	1300x800x1200	244





HTRE HT čistící kus

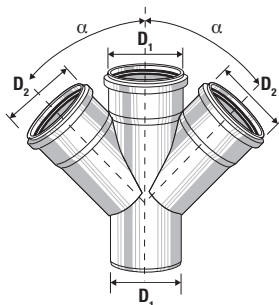

COD.	CL	D	DN				HxLxP 	Kč/ks
VS0516003	PP02	50	50	20	160	480	1015x800x1200	104
VS0516005	PP02	75	70	20	80	240	853x800x1200	107
VS0599151	PP02	90	90	20	80	160	940x800x1200	122
VS0516007	PP02	110	100	15	60	120	940x800x1200	132
VS0516009	PP02	125	125	10	40	80	940x800x1200	340
VS0516011	PP02	160	150	5	20	40	940x800x1200	539





HTDA HT dvojitá odbočka

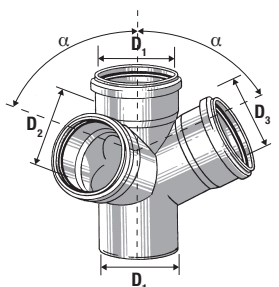

COD.	CL	D ₁ /D ₂	DN ₁ /DN ₂	α				HxLxP 	Kč/ks
VS0506001	PP02	50/50	50/50	67°30'	20	160	480	1015x800x1200	186
VS0506005	PP02	75/75	70/70	67°30'	10	40	120	853x800x1200	220
VS0599085	PP02	90/40	90/40	45°	15	60	180	853x800x1200	220
VS0599087	PP02	90/50	90/50	45°	15	60	180	970x800x1200	190
VS0506008	PP02	110/50	100/50	45°	10	40	120	853x800x1200	190
VS0506009	PP02	110/50	100/50	67°30'	10	40	120	853x800x1200	230
VS0506011	PP02	110/50	100/50	87°30'	10	40	120	853x800x1200	203
VS0506013	PP02	110/110	100/100	67°30'	5	20	60	970x800x1200	203
VS0506015	PP02	110/110	100/100	87°30'	5	20	60	970x800x1200	211





HTED HT D1 67°30' rohová dvojodbočka

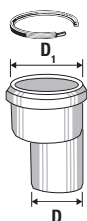

COD.	CL	D ₁ /D ₂ /D ₃	DN ₁ /DN ₂ /DN ₃	α				HxLxP 	Kč/ks
VS0512001	PP02	110/110/110	100/100/100	67°30'	5	20	60	1039x800x1200	412
VS0512003	PP02	110/50/110	100/50/100	67°30'	5	20	60	970x800x1200	431
VS0512005	PP02	110/110/50	100/100/50	67°30'	5	20	60	970x800x1200	431
VS0512007	PP02	110/50/50	100/50/50	67°30'	10	40	120	853x800x1200	431

HT redukce



COD.	CL	D/D ₁	DN/DN ₁				HxLxP 	Kč/ks
VS0700033	PP02	40/50	40/50	30	240	1680	970x800x1200	45
VS0700034	PP02	32/40	30/40	30	240	1920	930x800x1200	45

HTR

HT redukce – varianta A dlouhá, varianta B krátká

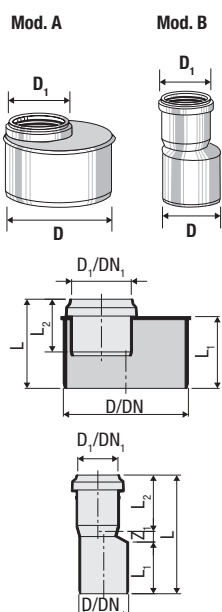

COD.	CL	D/D ₁	DN/DN ₁	Z ₁	L	L ₁	L ₂	Mod.				HxLxP	Kč/ks
VS0514001	PP02	40/32	40/30	12	98	41	44	B	50	400	2400	970x800x1200	29
VS0514002	PP02	50/32	50/30	15	98	38	44	B	40	320	1920	970x800x1200	36
VS0514003	PP02	50/40	50/40	13	125	51	58	B	50	400	1600	1010x800x1200	23
VS0514005	PP02	75/40	70/40	54	75	60	58	A	30	240	960	850x800x1200	47
VS0514007	PP02	75/50	70/50	50	75	59	58	A	30	240	960	850x800x1200	28
VS0599131	PP02	90/40	90/40	-	77	61	46,5	A	20	160	640	850x800x1200	31
VS0599133	PP02	90/50	90/50	-	76	61	45,5	A	20	160	640	850x800x1200	31
VS0514009	PP02	110/50	100/50	50	82	66	54	A	20	160	640	1010x800x1200	36
VS0514011	PP02	110/75	100/70	55	82	66	56	A	20	160	640	1010x800x1200	40
VS0514013	PP02	125/75	125/70	55	85	70	55	A	20	160	480	1015x800x1200	78
VS0514015	PP02	125/110	125/100	60	86	68	61	A	30	120	360	853x800x1200	78
VS0514017	PP02	160/110	150/100	80	173	97	81	A	20	80	240	940x800x1200	203
VS0514019	PP02	160/125	150/125	80	160	92	82	A	20	80	240	940x800x1200	214

HTSW

HT sifonové koleno s pryžovou manžetou

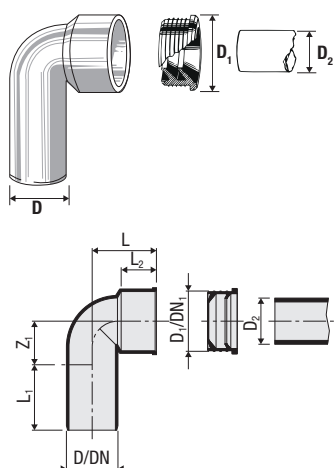

COD.	CL	D/D ₁	D ₂	DN ₁ /DN ₂	Z ₁	L	L ₁	L ₂				HxLxP	Kč/ks
VS0518003	PP02	32/46	24-32	30/40	23	50	51	27	40	320	1280	850x800x1200	37
VS0518007	PP02	40/46	24-32	40/40	23	50	51	30	40	320	1280	850x800x1200	37
VS0518009	PP02	40/46	36-40	40/40	23	50	51	30	40	320	1280	850x800x1200	37
VS0518013	PP02	40/53,5	24-32	40/50	28	52	52	27	20	160	960	970x800x1200	37
VS0518015	PP02	40/53,5	36-40	40/50	28	52	52	27	20	160	960	970x800x1200	37
VS0518017	PP02	50/53,5	24-32	50/50	28	52	52	28	20	160	960	970x800x1200	42
VS0518019	PP02	50/53,5	36-40	50/50	28	52	52	28	20	160	960	970x800x1200	42
VS0518021	PP02	50/60	46-55	50/50	28	52	52	28	20	160	960	970x800x1200	53

HTSW

HT sifonové koleno s přechodem na litinu

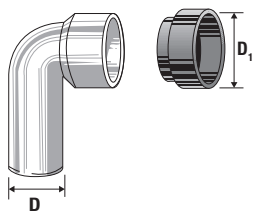

COD.	CL	D/D ₁	DN/DN ₁	Z ₁	L	L ₁	L ₂				HxLxP	Kč/ks
VS0518103	PP02	32/46	30/40	23	50	51	27	40	320	1280	850x800x1200	43
VS0518107	PP02	40/46	40/40	23	50	51	30	40	320	1280	850x800x1200	43

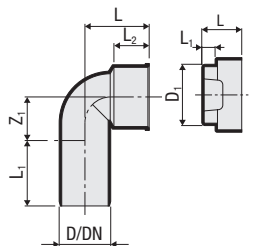

HTS

HT přechod přímý s pryžovou manžetou

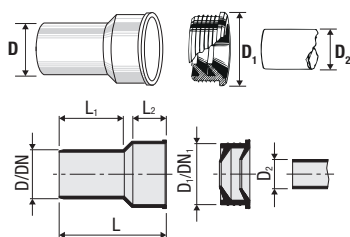

COD.	CL	D/D ₁	D ₂	DN/DN ₁	L	L ₁	L ₂				HxLxP	Kč/ks
VS0522003	PP02	32/46	24-32	30/40	88	54	26	40	320	1920	970x800x1200	42
VS0522007	PP02	40/46	24-32	40/40	88	54	26	40	320	1280	850x800x1200	42
VS0522009	PP02	40/46	36-40	40/40	88	54	26	40	320	1920	970x800x1200	42
VS0522013	PP02	40/50	24-32	40/50	88	54	28	40	320	1280	850x800x1200	42
VS0522015	PP02	40/50	36-40	40/50	88	54	28	40	320	1280	850x800x1200	47
VS0522017	PP02	40/53,5	36-40	40/50	70	38	24	40	320	1280	850x800x1200	47
VS0522019	PP02	50/53,5	24-32	50/50	88	54	28	20	160	960	970x800x1200	47
VS0522021	PP02	50/53,5	36-40	50/50	88	54	26	20	160	960	970x800x1200	48

HTS

HT přechod přímý s přechodkou na litinu

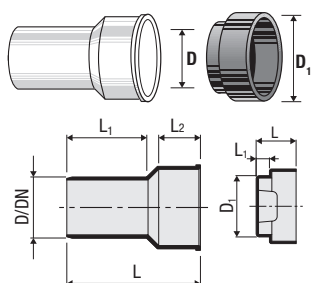

COD.	CL	D/D ₁	DN/DN ₁	L	L ₁	L ₂				HxLxP	Kč/ks
VS0522103	PP02	32/46	30/40	88	54	26	40	320	1920	970x800x1200	29
VS0522107	PP02	40/46	40/40	88	54	26	40	320	1920	970x800x1200	29

Náhradní díly

HTGM
náhradní pryžová redukce

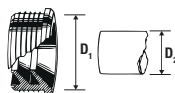

COD.	CL	D ₁	D ₂				HxLxP	Kč/ks
VS0334003 *	CC01	46	24-32	100	800	8000	1130x800x1200	14
VS0334005 *	CC01	46	36-40	150	1200	7200	1060x800x1200	14
VS0523009	PP02	50	24-32	30	600	4200	935x800x1200	24
VS0523011	PP02	50	36-40	30	600	4200	935x800x1200	22
VS0523015	PP02	53,5	24-32	30	600	4200	935x800x1200	22
VS0523017	PP02	53,5	36-40	30	600	4200	935x800x1200	22
VS0523019	PP02	60	46-55	30	600	4200	935x800x1200	24

* Bez: Zubehör-Preiliste

HTM
HT zátka

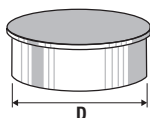







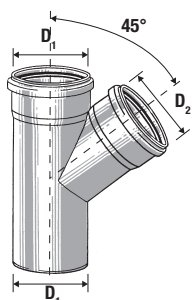

COD.	CL	D	DN				HxLxP	Kč/ks
VS0524001	PP02	40	40	40	800	5600	935x800x1200	14
VS0524003	PP02	50	50	20	400	2800	935x800x1200	18
VS0524005	PP02	75	70	15	300	2100	935x800x1200	23
VS0599141	PP02	90	90	30	240	1440	970x800x1200	24
VS0524007	PP02	110	100	20	160	960	970x800x1200	26
VS0524009	PP02	125	125	10	80	480	970x800x1200	72
VS0524011	PP02	160	150	10	80	320	1010x800x1200	132

HTEA

HT odbočka 45°, 67°, 87°







COD.	CL	D ₁ /D ₂	DN ₁ /DN ₂	α				HxLxP 	Kč/ks
VS0508001	PP02	32/32	30/30	45°	40	320	1280	850x800x1200	41
VS0508003	PP02	32/32	30/30	67°30'	40	320	1280	850x800x1200	41
VS0508005	PP02	32/32	30/30	87°30'	40	320	1280	850x800x1200	41
VS0510001	PP02	40/32	40/30	45°	40	320	1280	1010x800x1200	42
VS0510003	PP02	40/32	40/30	67°30'	40	320	1280	1010x800x1200	42
VS0510005	PP02	40/32	40/30	87°30'	40	320	1280	1010x800x1200	42
VS0508007	PP02	40/40	40/40	45°	20	160	640	850x800x1200	36
VS0508009	PP02	40/40	40/40	67°30'	20	160	640	850x800x1200	36
VS0508011	PP02	40/40	40/40	87°30'	20	160	640	850x800x1200	36
VS0510007	PP02	50/40	50/40	45°	20	160	640	1010x800x1200	48
VS0510009	PP02	50/40	50/40	67°30'	25	200	800	1010x800x1200	48
VS0510011	PP02	50/40	50/40	87°30'	25	200	800	1010x800x1200	48
VS0508013	PP02	50/50	50/50	45°	20	160	640	1010x800x1200	51
VS0508015	PP02	50/50	50/50	67°30'	20	160	640	1010x800x1200	51
VS0508017	PP02	50/50	50/50	87°30'	20	160	640	1010x800x1200	51
VS0510013	PP02	75/40	70/40	45°	25	100	300	853x800x1200	56
VS0510015	PP02	75/40	70/40	67°30'	25	100	300	853x800x1200	56
VS0510017	PP02	75/40	70/40	87°30'	25	100	300	853x800x1200	56
VS0510019	PP02	75/50	70/50	45°	25	100	300	970x800x1200	57
VS0510021	PP02	75/50	70/50	67°30'	25	100	300	970x800x1200	57
VS0510023	PP02	75/50	70/50	87°30'	25	100	300	853x800x1200	57
VS0508019	PP02	75/75	70/70	45°	20	80	240	970x800x1200	65
VS0508021	PP02	75/75	70/70	67°30'	20	80	240	970x800x1200	65
VS0508023	PP02	75/75	70/70	87°30'	20	80	240	853x800x1200	65
VS0599061	PP02	90/90	90/90	45°	20	80	160	940x800x1200	71
VS0599065	PP02	90/90	90/90	87°30'	20	80	160	940x800x1200	71
VS0599071	PP02	90/40	90/40	45°	20	80	240	853x800x1200	63
VS0599073	PP02	90/50	90/50	45°	20	80	240	970x800x1200	63
VS0599075	PP02	90/40	90/40	87°30'	20	80	240	853x800x1200	63
VS0599077	PP02	90/50	90/50	87°30'	20	80	240	853x800x1200	63
VS0510025	PP02	110/40	100/40	45°	20	80	160	940x800x1200	86
VS0510027	PP02	110/40	100/40	67°30'	20	80	160	940x800x1200	86
VS0510029	PP02	110/40	100/40	87°30'	20	80	240	1039x800x1200	86
VS0510031	PP02	110/50	100/50	45°	20	80	160	940x800x1200	72
VS0510033	PP02	110/50	100/50	67°30'	20	80	160	940x800x1200	72
VS0510035	PP02	110/50	100/50	87°30'	20	80	160	940x800x1200	72

COD.	CL	D ₁ /D ₂	DN ₁ /DN ₂	α				HxLxP 	Kč/ks
VS0510037	PP02	110/75	100/70	45°	15	60	120	940x800x1200	79
VS0510039	PP02	110/75	100/70	67°30'	15	60	120	940x800x1200	79
VS0510041	PP02	110/75	100/70	87°30'	15	60	120	940x800x1200	79
VS0508025	PP02	110/110	100/100	45°	15	60	120	1150x800x1200	91
VS0508027	PP02	110/110	100/100	67°30'	20	80	160	1300x800x1200	91
VS0508029	PP02	110/110	100/100	87°30'	20	80	160	1150x800x1200	91
VS0510043	PP02	125/50	125/50	45°	10	40	120	970x800x1200	261
VS0510045	PP02	125/50	125/50	67°30'	10	40	120	1039x800x1200	261
VS0510047	PP02	125/50	125/50	87°30'	10	40	120	1039x800x1200	261
VS0510049	PP02	125/110	125/100	45°	8	32	64	940x800x1200	261
VS0510051	PP02	125/110	125/100	67°30'	8	32	64	940x800x1200	261
VS0510053	PP02	125/110	125/100	87°30'	8	32	96	1039x800x1200	261
VS0508031	PP02	125/125	125/125	45°	10	40	80	1300x800x1200	1100
VS0508033	PP02	125/125	125/125	67°30'	5	20	60	1039x800x1200	1100
VS0508035	PP02	125/125	125/125	87°30'	10	40	80	940x800x1200	1100
VS0510061	PP02	160/110	150/100	45°	5	20	40	940x800x1200	934
VS0510063	PP02	160/110	150/100	67°30'	5	20	40	940x800x1200	934
VS0510065	PP02	160/110	150/100	87°30'	5	20	40	940x800x1200	934
VS0510067	PP02	160/125	150/125	45°	5	20	40	940x800x1200	1341
VS0510069	PP02	160/125	150/125	67°30'	5	20	40	940x800x1200	1341
VS0510071	PP02	160/125	150/125	87°30'	5	20	40	940x800x1200	1341
VS0508037	PP02	160/160	150/150	45°	1	-	30	930x800x1200	1602
VS0508039	PP02	160/160	150/150	67°30'	1	-	32	930x800x1200	1602
VS0508041	PP02	160/160	150/150	87°30'	4	16	32	940x800x1200	1602

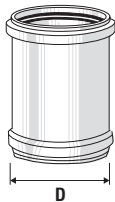
HTU

HT přesuvné hrdlo - hladké hrdlo





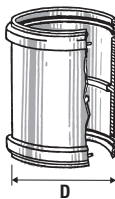

COD.	CL	D	DN				HxLxP 	Kč/ks
VS0526000	PP02	32	30	60	480	2880	970x800x1200	32
VS0526001	PP02	40	40	30	240	1440	970x800x1200	25
VS0526003	PP02	50	50	30	240	1440	970x800x1200	26
VS0526005	PP02	75	70	20	160	640	1010x800x1200	44
VS0599101	PP02	90	90	20	160	480	1015x800x1200	49
VS0526007	PP02	110	100	20	80	240	970x800x1200	54
VS0526009	PP02	125	125	20	80	160	940x800x1200	187
VS0526011	PP02	160	150	10	40	80	940x800x1200	314

HTMM

HT spojka s středový doraz





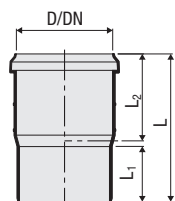
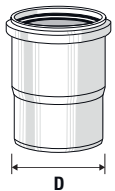

COD.	CL	D	DN				HxLxP 	Kč/ks
VS0528000	PP02	32	30	60	480	2880	970x800x1200	32
VS0528001	PP02	40	40	30	240	1440	970x800x1200	25
VS0528003	PP02	50	50	30	240	1440	970x800x1200	26
VS0528005	PP02	75	70	20	160	640	1010x800x1200	44
VS0599111	PP02	90	90	20	160	480	1015x800x1200	49
VS0528007	PP02	110	100	20	80	240	970x800x1200	54
VS0528009	PP02	125	125	20	80	160	940x800x1200	187
VS0528011	PP02	160	150	10	40	80	940x800x1200	314

HTL

HT dlouhé hrdlo-spojka



COD.	CL	D	DN	L	L ₁	L ₂				HxLxP 	Kč/ks
VS0531001	PP02	40	40	165	48	110	30	240	960	850x800x1200	56
VS0531015	PP02	50	50	225	50	170	20	160	640	850x800x1200	59
VS0531005	PP02	75	70	169	53	123	20	160	480	1015x800x1200	69
VS0599121	PP02	90	90	160	59	94	10	80	320	1010x800x1200	80
VS0531011	PP02	110	100	245	63	175	20	80	160	940x800x1200	91
VS0531009	PP02	125	125	220	70	145	10	40	120	853x800x1200	177

HTUG HT prodlužovací kus

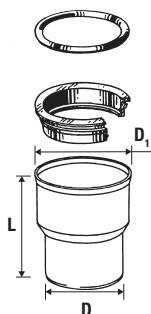

COD.	CL	D/D ₁	DN	L				HxLxP	Kč/ks
VS0569001	PP02	50/72	50	151	20	160	960	970x800x1200	72
VS0569003	PP02	75/92	70	148	20	160	640	1010x800x1200	86
VS0569005	PP02	110/124	100	160	20	80	240	859x800x1200	116
VS0569007	PP02	125/151	125	184	10	40	120	853x800x1200	575

HT náhradní díly

Těsnění pro HTUG

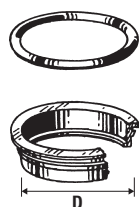

COD.	CL	D				HxLxP	Kč/ks
VS0581005	PP02	72	20	400	2800	935x800x1200	32
VS0581007	PP02	92	20	400	2800	935x800x1200	43
VS0581011	PP02	124	20	160	1280	930x800x1200	48
VS0581013	PP02	151	5	100	700	935x800x1200	67

HT náhradní břitový těsnící kroužek

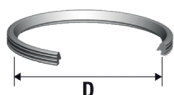

COD.	CL	D		Kč/ks
VS0391001	CC01	32	50	4
VS0391003	CC01	40	50	4
VS0391005	CC01	50	50	5
VS0391011	CC01	75	20	8
VS0391013	CC01	90	20	10
VS0391015	CC01	110	20	11
VS0391017	CC01	125	20	18
VS0391019	CC01	160	20	24





HT redukce

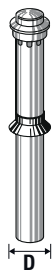

COD.	CL	D/D ₁	DN/DN ₁				HxLxP	Kč/ks
VS0513000	PP02	40/32	40/30	100	800	4800	970x800x1200	41
VS0513001	PP02	50/40	50/40	80	640	3200	1030x800x1200	41
VS0599135	PP02	90/75	90/70	20	160	640	850x800x1200	42
VS0599137	PP02	110/90	100/90	20	160	640	1010x800x1200	42

HT odvodušňovací ventil (PVC barva šedá)



COD.	CL	D	DN				HxLxP 	Kč/ks
VS0394001	CC01	50	50	10	30	120	120x800x1200	467
VS0394003	CC01	75	70	5	15	60	120x800x1200	519
VS0394005	CC01	110	100	5	15	45	120x800x1200	585

HT náhradní víčko pro čistící kusy

COD.	CL	DN		Kč/ks
VS0516075	CC01	70	1	58
VS0516110	CC01	100	1	61

HT vazelína







COD.	CL	g		Kč/ks
VS0900001	CC01	150	50	45
VS0900003	CC01	250	50	55

Certifikace



Popisky

Symbol	Měrná jednotka	Název
Kč/ks	-	Cena za kus v Kč bez DPH
COD.	-	Kód
CL	-	Rabatová skupina
D	mm	Vnější rozměr
DN	mm	Vnitřní rozměr - světlost
	n°	Počet kusů v kartonu
	n°	Počet ks na paletě v jedné rovině
	n°	Počet ks na paletě
HxLxP 	mm	Rozměr palety
α	°	Úhel tvarovky
Mod.	-	Model

Všechny výrobky jsou v mm

Lined writing area with 20 horizontal lines and 8 circular icons on the right side.



VÝROBNÍ PROGRAM VALSIRU



ODPADNÍ SYSTÉMY



SYSTÉMY PRO ST,
TUV A ÚT

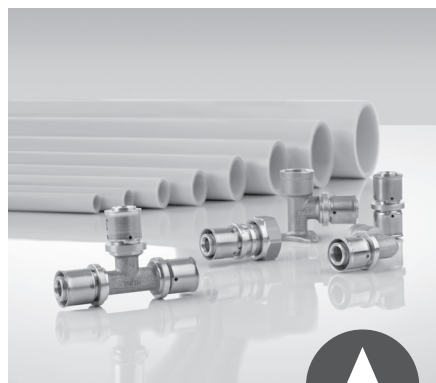

SYSTÉMY PRO
ROZVOD PLYNU



SPLACHOVACÍ
SYSTÉMY



KOUPELNOVÉ SYSTÉMY



SIFONY A VPUSTĚ

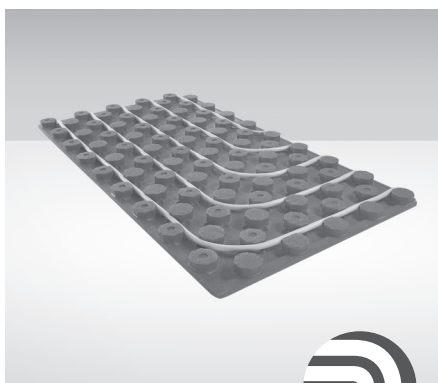

SYSTÉMY PODLA-
HOVÉHO VYTÁPĚNÍ



SYSTÉMY ODVÁDĚNÍ
SRAŽKOVÝCH VOD



ACADEMIE VALSIR



GENOVA
BOHEMIA®

Kontakt dovozce ČR:

Genova Bohemia s.r.o

Vídeňská 573

252 42 Vestec u Prahy

tel: +420 244 911 283

fax: +420 244 912 344

e-mail: info@genovaboheemia.cz

www.genovaboheemia.cz

MADE IN ITALY



prodejce:

valsir®
QUALITY FOR PLUMBING