



HDPE and PP traps

Siphons aus PP und HDPE

TRAPS AND GULLIES: A WORLD OF HIGH PERFORMANCE SOLUTIONS

SIPHONS UND SCHACHTABLAUF: EINE WELT VOLLER LEISTUNGSSTARKER LÖSUNGEN



Valsir supplies a wide range of innovative and patented solutions to suit all requirements and installations.

The T-58 shallow trap, with a height of only 58 mm, is the ideal solution in installations with a reduced depth and limited height, guaranteeing maximum drainage efficiency.

The double hydraulic seal provides the capacity of sealing off odours far greater than standard requirements.

The Valsir range of traps and siphons also includes a range of grids and covers with an attractive and innovative design.

Zusätzlich zu den Abflussleitungen bietet Valsir ein großes Sortiment innovativer und patentierter Lösungen für alle Anforderungen und Installationsarten.

So ist beispielsweise der superflache Siphon T-58 mit einer Höhe von nur 58 mm die ideale Lösung für Anlagen mit geringer Dicke oder geringer Höhe, die eine maximale Entwässerungsleistung garantieren, und dank seiner doppelten hydraulischen Schutzvorrichtung verfügt er über eine größere Kapazität zur Geruchsbekämpfung als gesetzlich vorgeschrieben.

Das Valsir-Sortiment an Siphons und Schachtabläufen wird von einer Reihe von Ablaufrosten und Abdeckungen mit einem attraktiven und innovativen Design begleitet.

- Full range to complement the HDPE and PP waste lines, to satisfy all types of installations.
 - Shallow systems for low height installations.
 - Systems composed of a trap with PVC sheet for waterproofing.
 - Functional and innovative design.
 - Completely accessible.
 - Compatible with all types of pipe systems on the market.
 - Manufactured with technologically advanced materials.
 - Adjustable systems for the latest in installation design.
 - The product, its recyclability and the production processes used are based on the Green Building principles.
- *Komplettes Sortiment zur Verwendung der HDPE- und PP-Abgasleitungen für jede Art von Installation.*
 - *Flache Systeme für Installationen bei geringer Einbauhöhe.*
 - *Systeme bestehend aus einem Siphon und einer PVC-Folie zur Abdichtung.*
 - *Funktionales und innovatives Design.*
 - *Vollständig inspizierbar.*
 - *Kompatibel mit allen auf dem Markt erhältlichen Rohrarten.*
 - *Produkte mit technologisch fortgeschrittenen Materialien.*
 - *Verstellbare Systeme für anspruchsvolle Installationen.*
 - *Das Produkt, seine Recyclingfähigkeit und die verwendeten Produktionsverfahren basieren auf den Prinzipien des Green Building.*



KITCHEN - TRAP FOR SINGLE BOWL SINKS

KÜCHE - SIPHONS FÜR EINZELSPÜLBECKEN

Bottle trap

Flaschengeruchsverschluss

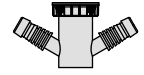
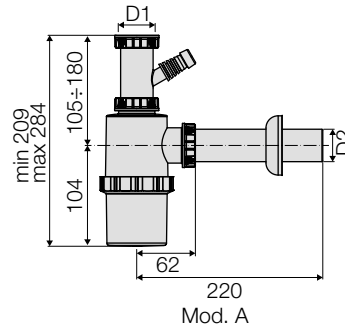

Mod. B

COD.	Mod.	D1	D2		CL	€/pz
VS0700601	A	1"½	40	5	SF01	7,23
VS0700603	A	1"¼	40	5	SF01	7,70
VS0700602	B	1"½	40	5	SF01	8,23

Set-up for dishwasher connection with blanking cap. - Auslegung für Spülmaschinenanschluss mit Verschlussstopfen.

Bottle trap "German" model

Flaschengeruchsverschluss

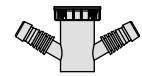
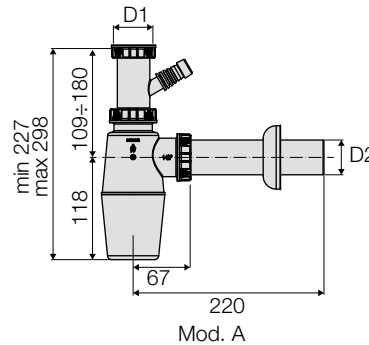

Mod. B

COD.	Mod.	D1	D2		CL	€/pz
VS0700611	A	1"½	40	5	SF01	7,23
VS0700613	A	1"¼	40	5	SF01	7,70
VS0700612	B	1"½	40	5	SF01	8,23

Set-up for dishwasher connection with blanking cap. - Auslegung für Spülmaschinenanschluss mit Verschlussstopfen.

Shallow trap

Flacher Siphon

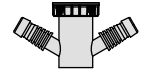
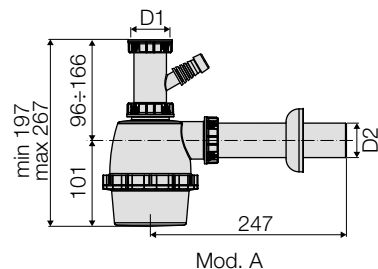

Mod. B

COD.	Mod.	D1	D2		CL	€/pz
VS0700625	A	1"¼	32	5	SF01	7,23
VS0700623	A	1"¼	40	5	SF01	7,70
VS0700621	A	1"½	40	5	SF01	7,23
VS0700622	B	1"½	40	5	SF01	8,23

Set-up for dishwasher connection with blanking cap. - Auslegung für Spülmaschinenanschluss mit Verschlussstopfen.

KITCHEN - TRAP FOR DOUBLE BOWL SINKS

KÜCHE - SIPHONS FÜR DOPPELSPÜLBECKEN

Bottle trap

Flaschengeruchsverschluss

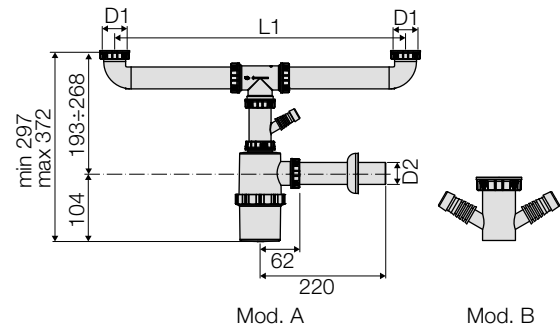

COD.	Mod.	D1	D2	L1		CL	€/pz
VS0700605	A	1"½	40	max 553	5	SF01	12,68
VS0700607	A	1"¼	40	max 303	5	SF01	13,08
VS0700606	B	1"½	40	max 553	5	SF01	14,00

Set-up for dishwasher connection with blanking cap. - Auslegung für Spülmaschinenanschluss mit Verschlussstopfen.

Bottle trap "German" model

Flaschengeruchsverschluss

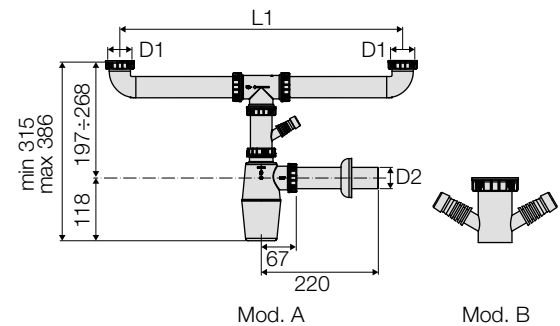

COD.	Mod.	D1	D2	L1		CL	€/pz
VS0700615	A	1"½	40	max 553	5	SF01	12,68
VS0700617	A	1"¼	40	max 303	5	SF01	13,08
VS0700616	B	1"½	40	max 553	5	SF01	14,00

Set-up for dishwasher connection with blanking cap. - Auslegung für Spülmaschinenanschluss mit Verschlussstopfen.

Shallow trap

Flacher Siphon

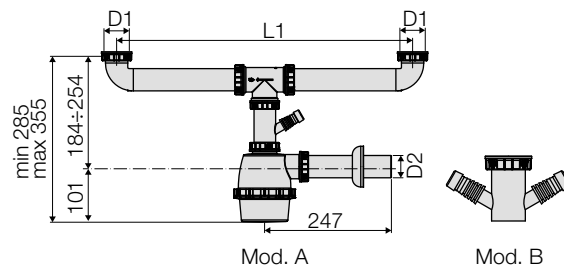

COD.	Mod.	D1	D2	L1		CL	€/pz
VS0700631	A	1"¼	32	max 303	5	SF01	12,68
VS0700629	A	1"¼	40	max 303	5	SF01	13,08
VS0700627	A	1"½	40	max 553	5	SF01	12,68
VS0700628	B	1"½	40	max 553	5	SF01	14,00

Set-up for dishwasher connection with blanking cap. - Auslegung für Spülmaschinenanschluss mit Verschlussstopfen.

KITCHEN - TRAPS FOR ONE AND A HALF BOWL SINKS

KÜCHE - SIPHONS FÜR DOPPELSPÜLBECKEN 1 ½ BECKEN

Bottle trap

Flaschengeruchsverschluss

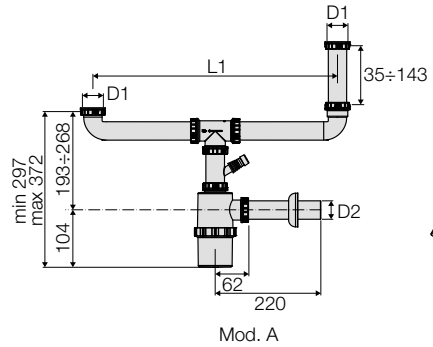

COD.	Mod.	D1	D2	L1		CL	€/pz
VS0700609	A	1"½	40	max 553	5	SF01	14,17
VS0700610	B	1"½	40	max 553	5	SF01	14,99

Set-up for dishwasher connection with blanking cap. - Auslegung für Spülmaschinenanschluss mit Verschlussstopfen.

Bottle trap "German" model

Flaschengeruchsverschluss

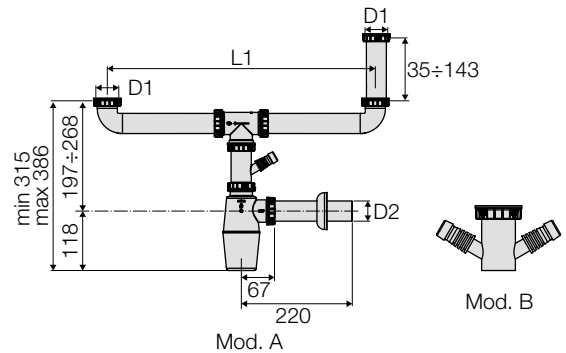

COD.	Mod.	D1	D2	L1		CL	€/pz
VS0700619	A	1"½	40	max 553	5	SF01	13,66
VS0700620	B	1"½	40	max 553	5	SF01	14,99

Set-up for dishwasher connection with blanking cap. - Auslegung für Spülmaschinenanschluss mit Verschlussstopfen.

Shallow trap

Flacher Siphon

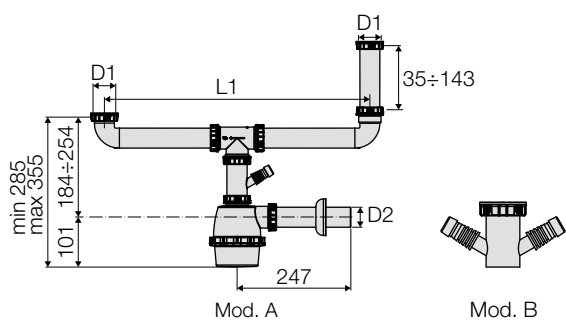

COD.	Mod.	D1	D2	L1		CL	€/pz
VS0700633	A	1"½	40	max 553	5	SF01	13,66
VS0700634	B	1"½	40	max 553	5	SF01	14,99

Set-up for dishwasher connection with blanking cap. - Auslegung für Spülmaschinenanschluss mit Verschlussstopfen.

KITCHEN - SELF-CLEANING TRAPS FOR SINKS

KÜCHE - SELBSTREINIGENDE RÖHRENGERUCHSVERSCHLÜSSE

- FÜR SPÜLEN

Self-cleaning trap for single bowl sinks

Röhrengeruchsverschluss für Einzelspülbecken

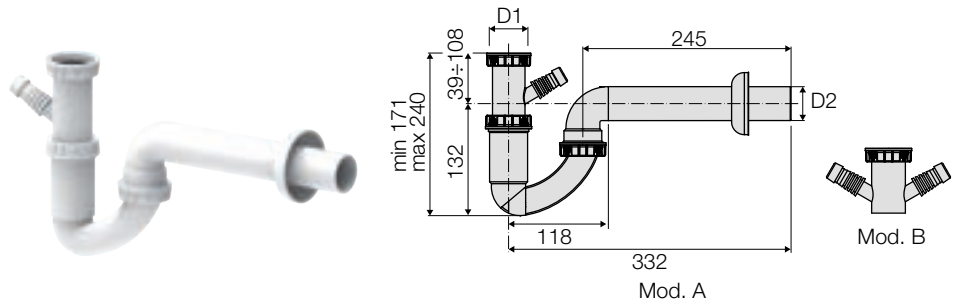

COD.	Mod.	Type - Typ	D1	D2		CL	€/pz
VS0700635	A	Single basin - Einzelspülbecken	1"½	40	5	SF01	10,02
VS0700636	A	Single basin - Einzelspülbecken	1"¼	40	5	SF01	10,31
VS0700207	B	Single basin - Einzelspülbecken	1"½	40	5	SF01	11,00

Set-up for dishwasher connection with blanking cap. - Auslegung für Spülmaschinenanschluss mit Verschlussstopfen.

Self-cleaning trap for double bowl sinks

Selbstreinigender Röhrengeruchsverschluss für Doppelspülbecken

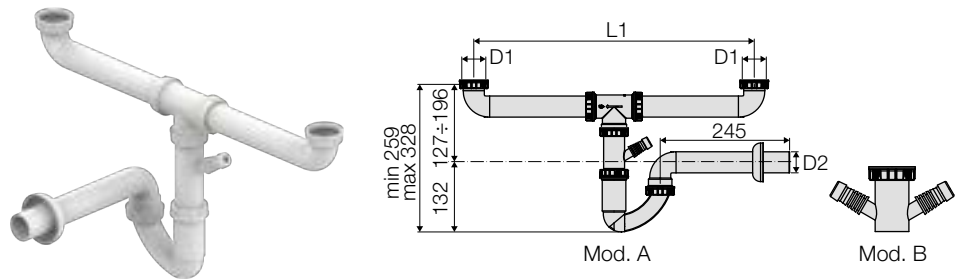

COD.	Mod.	Type - Typ	D1	D2	L1		CL	€/pz
VS0700637	A	Twin basin - Doppelspülbecken	1"½	40	max 553	5	SF01	15,74
VS0700638	A	Twin basin - Doppelspülbecken	1"¼	40	max 303	5	SF01	16,09
VS0700210	B	Twin basin - Doppelspülbecken	1"½	40	max 553	5	SF01	16,78

Set-up for dishwasher connection with blanking cap. - Auslegung für Spülmaschinenanschluss mit Verschlussstopfen.

Self-cleaning trap for one and a half bowl sinks

Selbstreinigender Röhrengeruchsverschluss für Eineinhalb-spülbecken

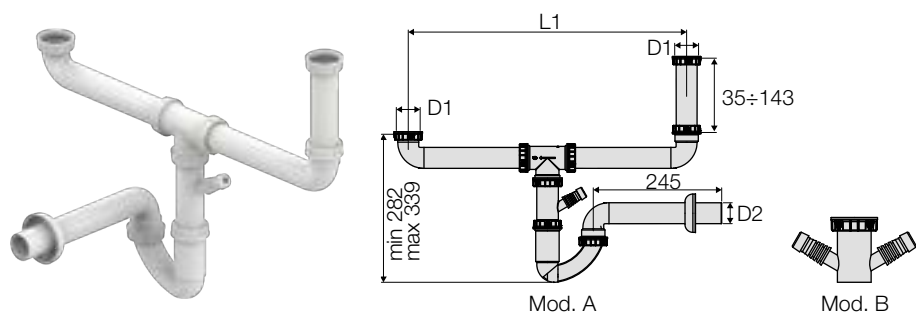

COD.	Mod.	Type - Typ	D1	D2	L1		CL	€/pz
VS0700639	A	1 and ½ basin - Doppelspülbecken 1 ½ Becken	1"½	40	max 553	5	SF01	16,73
VS0700640	B	1 and ½ basin - Doppelspülbecken 1 ½ Becken	1"½	40	max 553	5	SF01	17,76

Set-up for dishwasher connection with blanking cap. - Auslegung für Spülmaschinenanschluss mit Verschlussstopfen.

TRAPS
ABLAUFSIPHONS

KITCHEN - SPACE-SAVING TRAP FOR SINKS

KÜCHE - PLATZSPARENDER RÖHRENGERUCHSVERSCHLUSS



Space-saving self-cleaning trap for single bowl sinks

Platzsparender Röhrengeruchsverschluss für Einzelspülbecken

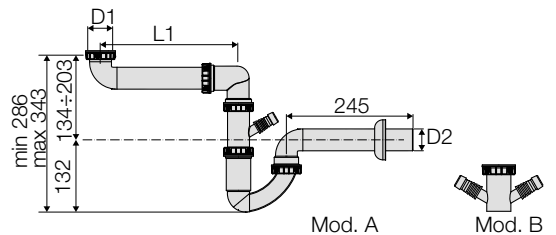
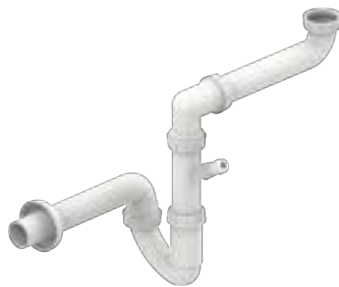

COD.	Mod.	Type - Typ	D1	D2	L1		CL	€/pz
VS0700641	A	Single basin - Einzelspülbecken	1"½	40	max 289	5	SF01	14,58
VS0700642	B	Single basin - Einzelspülbecken	1"½	40	max 289	5	SF01	15,74

Set-up for dishwasher connection with blanking cap. - Auslegung für Spülmaschinenanschluss mit Verschlussstopfen.

Space-saving self-cleaning trap for double basin sinks or one and a half bowl sinks

Selbstreinigender Röhrengeruchsverschluss für Eineinhalb-spülbecken

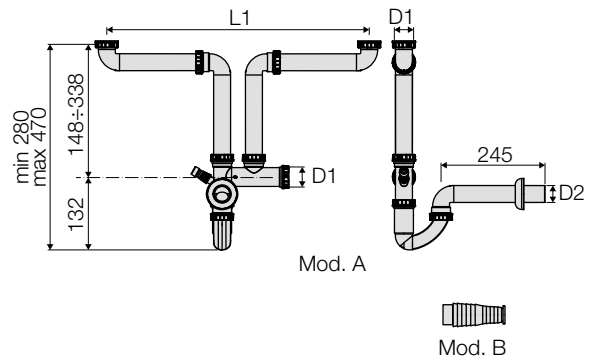

COD.	Mod.	Type - Typ	D1	D2	L1		CL	€/pz
VS0700643	A	Twin basin - Doppelspülbecken	1"½	40	max 645	5	SF01	20,78
VS0700644	B	Twin basin - Doppelspülbecken	1"½	40	max 645	5	SF01	22,17

Set-up for dishwasher connection with blanking cap. - Auslegung für Spülmaschinenanschluss mit Verschlussstopfen.

Space-saving self-cleaning trap for triple bowl sinks

Platzsparender Röhrengeruchsverschluss für Dreifachspülbecken

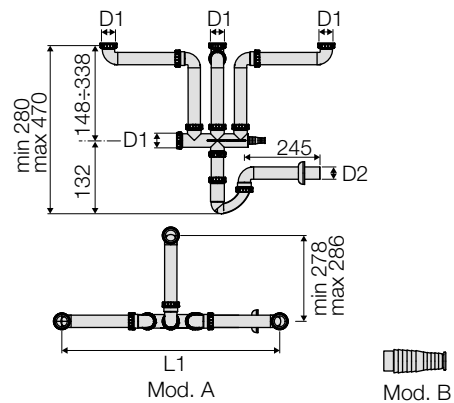
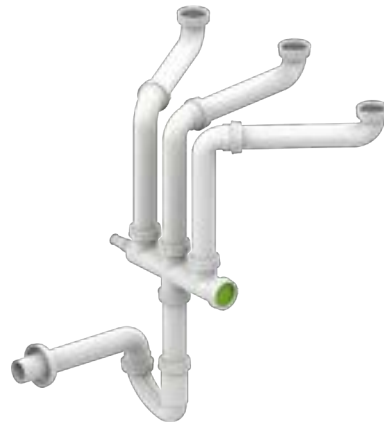

COD.	Mod.	Type - Typ	D1	D2	L1		CL	€/pz
VS0700645	A	Triple basin - Dreifachspülbecken	1"½	40	max 720	5	SF01	26,51
VS0700646	B	Triple basin - Dreifachspülbecken	1"½	40	max 720	5	SF01	28,01

Set-up for dishwasher connection with blanking cap. - Auslegung für Spülmaschinenanschluss mit Verschlussstopfen.

KITCHEN - EXTENDABLE TRAPS FOR SINKS

KÜCHE - BIEGBARE GERUCHSVERSCHLÜSSE FÜR SPÜLEN

Extendable trap Magic for single bowl sinks

Biegbarer Röhrengeruchverschluss für Einzelspülbecken

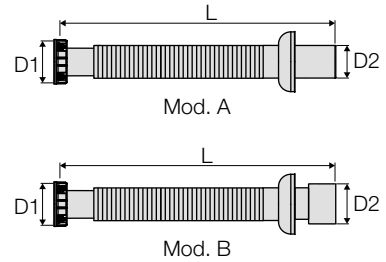

COD.	Mod.	Type	D1	D2	L		CL	€/pz
VS0700647 •	A	Single basin - Einzelspülbecken	1"½	40	340÷740	5	SF01	6,37
VS0700665	A	Single basin - Einzelspülbecken	1"½	40/50	340÷740	5	SF01	7,46
VS0700650 •	B	Single basin - Einzelspülbecken	1"¼	32	340÷770	5	SF01	6,71
VS0700666	B	Single basin - Einzelspülbecken	1"¼	32/40	340÷770	5	SF01	7,46

• Sell out. - Ausverkauf.

Extendable trap Magic for double bowl sinks

Biegbarer Röhrengeruchverschluss für Doppelspülbecken

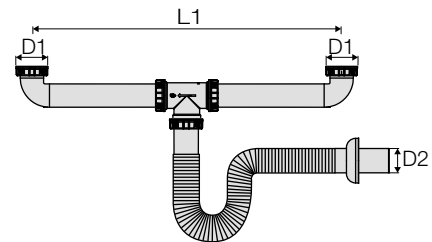

COD.	Mod.	D1	D2	L1		CL	€/pz
VS0700648	Twin basin - Doppelspülbecken	1"½	40	max 553	5	SF01	13,02

Extendable trap Magic for one and a half bowl sinks

Biegbarer Röhrengeruchverschluss für Eineinhalbspülbecken

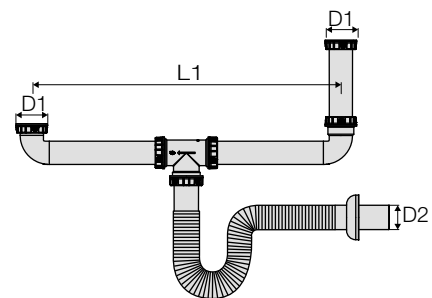



COD.	Mod.	D1	D2	L1		CL	€/pz
VS0700649	1 and ½ basin - Doppelspülbecken 1 ½ Becken	1"½	40	max 553	5	SF01	14,12

Accessories - Ersatzteile

Single dishwasher connection

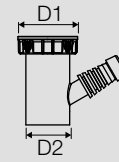
Einzelspülmaschinenanschluss



COD.	D1	D2		CL	€/pz
VS0703151	1"½	40	1	SF01	4,47

Double dishwasher connection

Doppelspülmaschinenanschluss

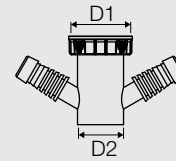

COD.	D1	D2		CL	€/pz
VS0703153	1"½	40	1	SF01	5,73

Cap with 1"½ threaded connection

Verschlussstopfen mit 1"½ Gewindeanschluss



COD.		CL	€/pz
VS0703155	5	SF01	1,91

Flat seal

Flachdichtung



COD.	D		CL	€/pz
VS0703024	1"¼	10	SF01	0,87
VS0703021	1"½	10	SF01	0,63

Conic seal

Konische Dichtung



COD.	D		CL	€/pz
VS0703141	32	10	SF01	0,76
VS0703025	40	10	SF01	0,76

KITCHEN - WASTE FOR SINKS

KÜCHE - ABLAUFGARNITUREN FÜR SPÜLBECKEN

3"½ drain with grate and overflow

3"½ Ablaufgarnitur mit Siebkorb und Überlauf

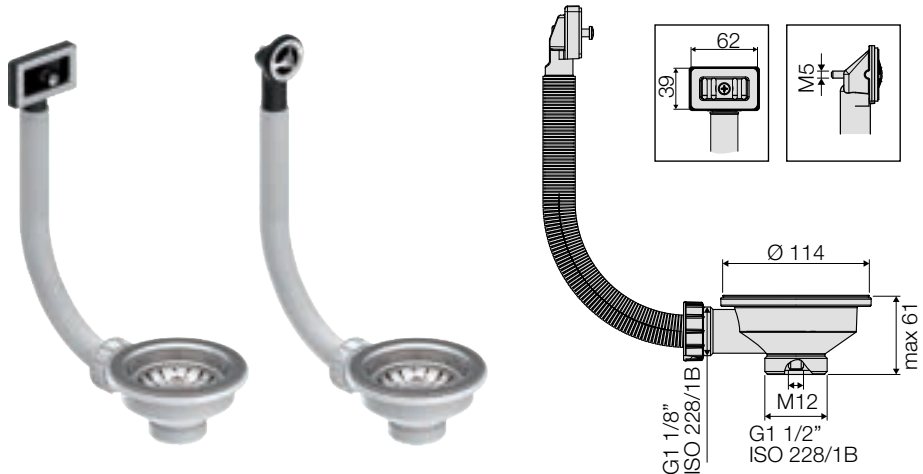

COD.	Mod. overflow - Überlauf		CL	€/pz
VS0700651	rectangular - rechteckig	5	SF01	16,09
VS0700653	round - runden	5	SF01	16,44

3"½ automatic waste with overflow

Excenter Ablaufgarnitur 3"½ mit Überlauf



COD.	Mod. overflow - Überlauf		CL	€/pz
VS0700662	rectangular - rechteckig	5	SF01	52,67
VS0700663	round - runden	5	SF01	53,01

3"½ drain with grate

3"½ Ablaufgarnitur mit Siebkorb



COD.	Mod. overflow - Überlauf		CL	€/pz
VS0700655	-	5	SF01	12,97

1"½ drain with grate and overflow

1"½ Ablaufgarnitur mit Siebkorb und Überlauf

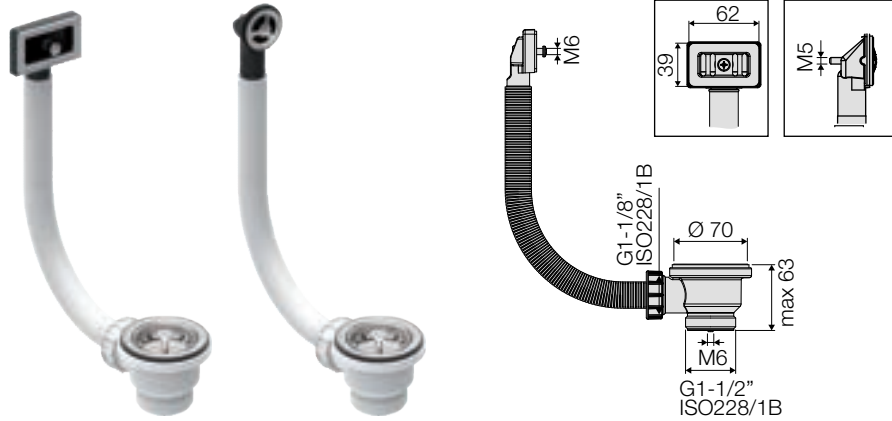

COD.	Mod. overflow - Überlauf		CL	€/pz
VS0700658	rectangular - rechteckig	5	SF01	18,75
VS0700659	round - runden	5	SF01	19,10

1"½ drain with cap and overflow

1"½ Ablaufgarnitur mit Stöpsel und Überlauf

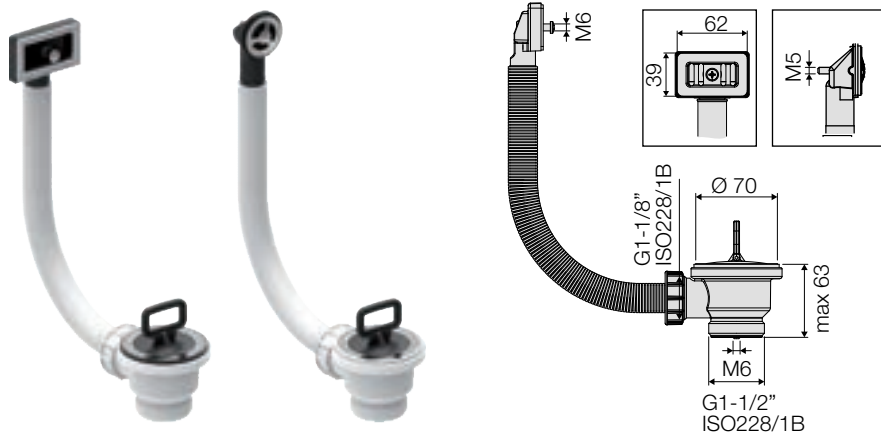

COD.	Mod. overflow - Überlauf		CL	€/pz
VS0700660	rectangular - rechteckig	5	SF01	9,20
VS0700661	round - runden	5	SF01	9,55

1"½ waste

1"½ Ablaufventil

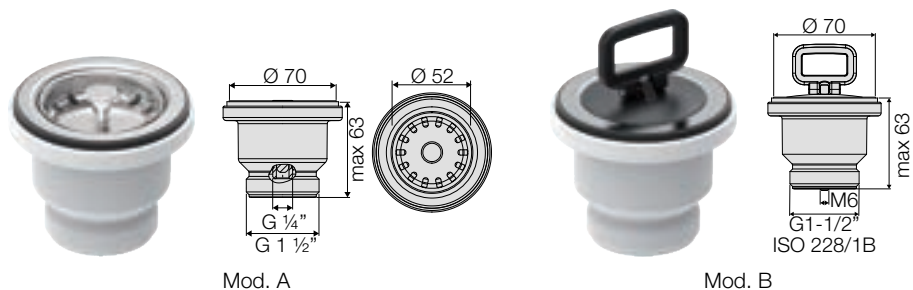

COD.	Mod.	Mod. overflow - Überlauf		CL	€/pz
VS0700657	A	-	5	SF01	14,58
VS0700664	B	-	5	SF01	6,54

KITCHEN - WASTE FOR SINKS
 KÜCHE - ABLAUFGARNITUREN FÜR SPÜLBECKEN

**Ø 80 waste with plug
 with for ceramic sink**
 Verschliessbares mit
 Stopfen für Keramikspüle

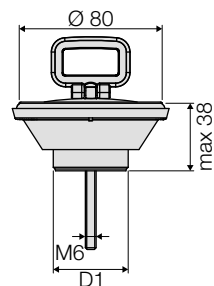

TRAPS
 ABLAUFSPHONS

COD.	Mod. overflow - Überlauf	D1		CL	€/pz
VS0700221	-	1"½	5	SF01	6,50
VS0700219	-	1"¼	5	SF01	6,13

BATHROOM - WASHBASIN AND BIDET TRAPS

BADEZIMMER - SIPHONS FÜR WASCHTISCHE UND BIDETS

Bottle trap

Flaschengeruchsverschluss

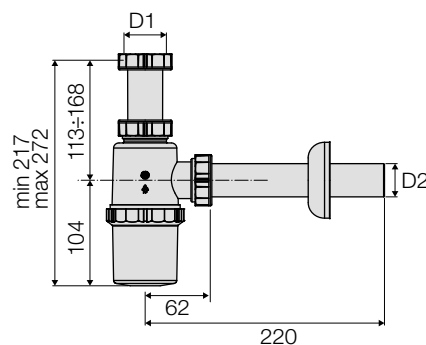

COD.	Mod.	D1	D2		CL	€/pz
VS0700342	Single basin - Einzelwaschtisch	1"¼	32	5	SF01	6,70
VS0700341	Single basin - Einzelwaschtisch	1"¼	40	5	SF01	7,00

Bottle trap "German" model

Flaschengeruchsverschluss

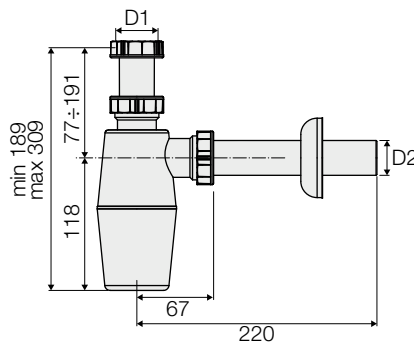

COD.	Mod.	D1	D2		CL	€/pz
VS0700223	Single basin - Einzelwaschtisch	1"¼	32	5	SF01	6,58
VS0700343	Single basin - Einzelwaschtisch	1"¼	40	5	SF01	7,12

TRAPS
ABLAUFSIPHONS

White PP trap for washbasin/washtub

Geruchsverschluss für
 Waschtisch/Ausgussbecken
 aus weißem PP

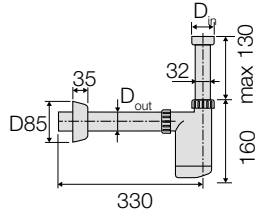

Mod. A1

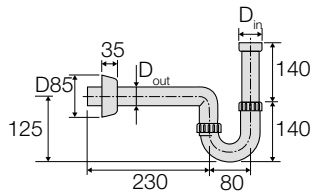

Mod. A2

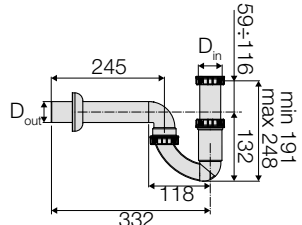

Mod. A3

COD.	Mod.	D _{out}	D _{in}				HxLxP	CL	€/pz
VS0700233 ♦	A1	40	1 1/4"	5	40	280	1110x800x1200	SF01	16,08
VS0700231 * ♦	A1	40	1 1/4"	5	40	280	1145x800x1200	SF01	18,56
VS0700214 ♦	A2	32	1 1/4"	5	40	280	1145x800x1200	SF01	10,16
VS0700204	A3	40	1 1/4"	5	40	280	1150x800x1200	SF01	9,84

* With grommet. - Mit Gummimanschette.

♦ Fixed threaded connection. - Ortsfester Gewindeanschluss.

Bidet trap in white PP

Geruchsverschluss für
 Bidet-Abfluss aus
 weißem PP

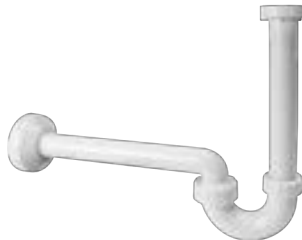

Mod. A1

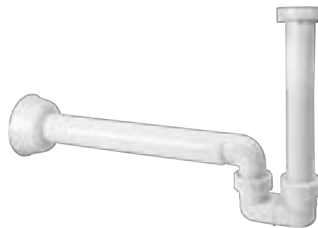
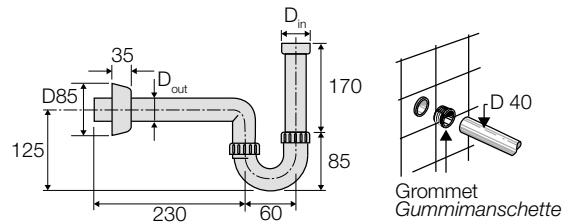

Mod. A2

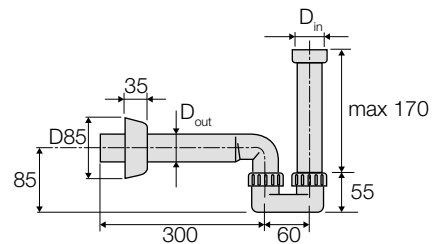

COD.	Mod.	D _{out}	D _{in}				HxLxP	CL	€/pz
VS0700208 ♦	A1	32	1 1/4"	5	40	280	1145x800x1200	SF01	10,63
VS0700206 ♦	A1	40	1 1/4"	5	40	280	1145x800x1200	SF01	10,67
VS0700216 *	A1	40	1 1/4"	5	40	280	935x800x1200	SF01	12,88
VS0700212 ♦	A2	40	1 1/4"	5	40	280	1150x800x1200	SF01	11,55

* With grommet. - Mit Gummimanschette.

♦ Fixed threaded connection. - Ortsfester Gewindeanschluss.

**Extendable trap
 Magic for single bowl
 sinks**

*Biegbarer Röhrenge-
 ruchsverschluss für
 Einzelspülbecken*

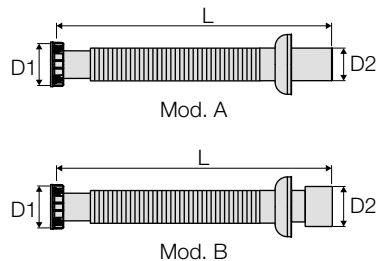

COD.	Mod.	Type	D1	D2	L		CL	€/pz
VS0700647 •	A	Single basin - Einzelspülbecken	1"½	40	340÷740	5	SF01	6,37
VS0700665	A	Single basin - Einzelspülbecken	1"½	40/50	340÷740	5	SF01	7,46
VS0700650 •	B	Single basin - Einzelspülbecken	1"¼	32	340÷770	5	SF01	6,71
VS0700666	B	Single basin - Einzelspülbecken	1"¼	32/40	340÷770	5	SF01	7,46

• Sell out. - Ausverkauf.

Accessories - Ersatzteile

**Single dishwasher
 connection**

Einzelspülmaschinenanschluss

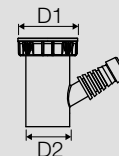

COD.	D1	D2		CL	€/pz
VS0703151	1"¼	32	1	SF01	4,47

Flat seal

Flachdichtung



COD.	D		CL	€/pz
VS0703024	1"¼	10	SF01	0,87
VS0703021	1"½	10	SF01	0,63

Conic seal

Konische Dichtung



COD.	D		CL	€/pz
VS0703141	32	10	SF01	0,76
VS0703025	40	10	SF01	0,76

TRAPS
 ABLAUFSIPHONS

BATHROOM - WASHBASIN AND BIDET TRAPS
 BADEZIMMER - SIPHONS FÜR WASCHTISCHE UND BIDETS

**Round overflow
 for stainless steel
 washbasin**

*Rundem Überlauf für
 Edelstahlspüle*

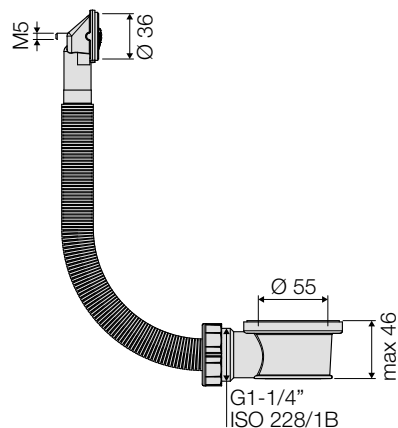

COD.		CL	€/pz
VS0700193	5	SF01	9,44

**1 1/4 waste without
 overflow, Ø 65 plug
 with handle, for
 ceramic washbasin**

*Ablaufventilgarnitur
 Ø 65 1-1/4" für Keramik-
 Waschtisch, Stopfen mit
 Griff*

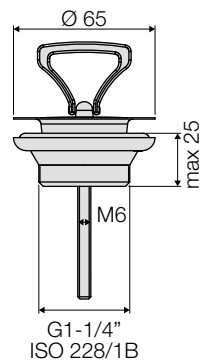

COD.		CL	€/pz
VS0700194	5	SF01	7,47

BATHROOM - POP-UP WASTE TRAPS FOR BATHTUBS

BADEZIMMER - BADEWANNEABLAUFGARNITUREN MIT SIPHON

Pop-up waste with chained plug

Badewannenablaufgarnitur mit Kettenstopfen

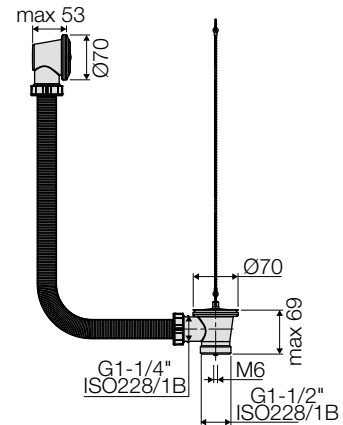

COD.		CL	€/pz
VS0700125	1	SF01	16,78

Universal bathtub pipe with drain, automatic cap and trap

Universelle Badewannen-Abflusssäule mit Ablaufgarnitur, automatischem Stöpsel und Siphon

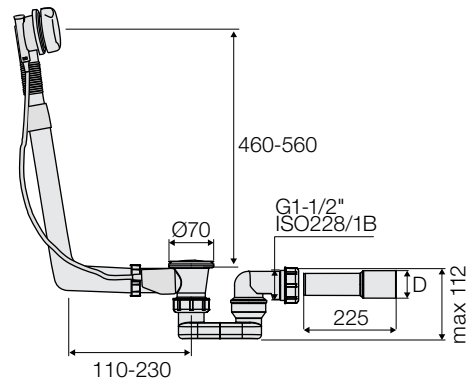

COD.	D	Type - Typ		CL	€/pz
VS0700197	40/50	Pop-up waste trap, with chrome knob plug, with swivel trap with nut and ring connection <i>Ablaufgarnitur mit Schraubverbindung, Abflusssiphon mit Stopfen und Bediengriff aus poliertem Chrom</i>	1	SF01	89,24

Universal pop-up waste for bathtub adjustable in height and length. Trapped versions have HDPE traps incorporated with swivel connection. With knob operated versions, the plug is automatically opened and closed by turning the knob.

Universelle Badewannenablaufgarnitur mit Höhen- und Längenverstellung. Sie ist mit einem Siphon mit verstellbarem Anschluss ausgestattet. Der Abflusstropfen wird durch Drehen des Bediengriffs automatisch geschlossen und geöffnet.

HDPE traps for bathtub with brass or plastic nut, swivel connection

*Badewannenablaufsi-
phon mit Messing- oder
Kunststoffmutter, ver-
stellbarer Anschluss*

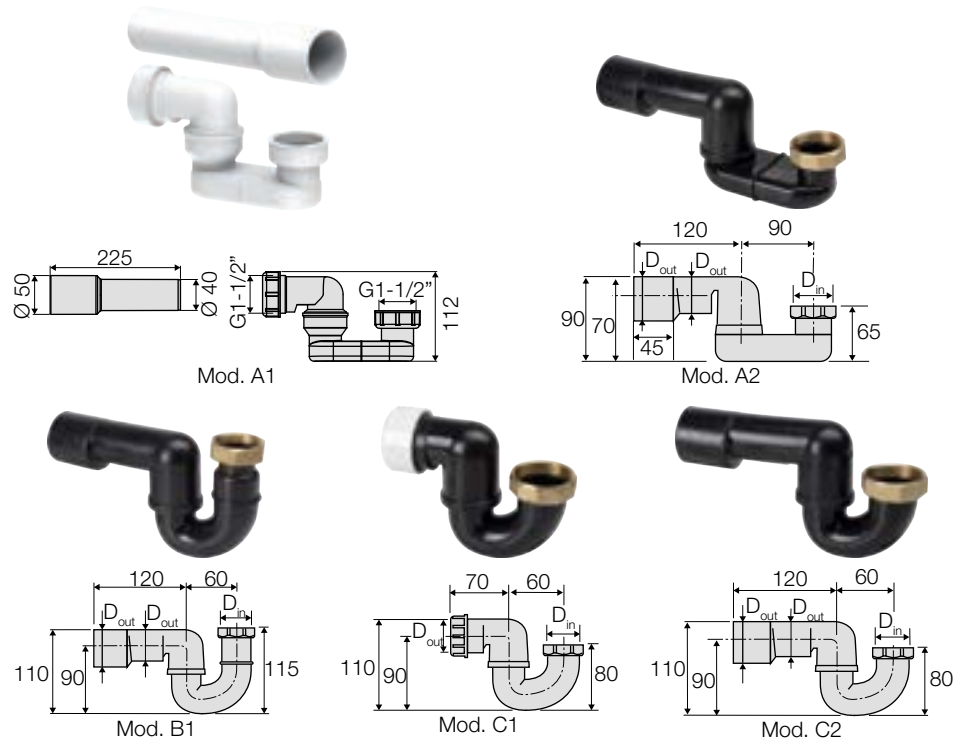

COD.	Mod.	D _{out}	D _{in}	Type - Typ				HxLxP	CL	€/pz
VS0700199	A1	40/50	1 1/2	Nut and ring connection <i>Schraubverbindung</i>	5	-	240	1145x800x1200	SF01	9,78
VS0700141	A2	40/50	1 1/4	Fusion weld connection <i>Schweissverbindung</i>	10	80	560	970x800x1200	SF01	16,63
VS0700144	A2	40/50	1 1/2	Fusion weld connection <i>Schweissverbindung</i>	10	80	560	970x800x1200	SF01	14,69
VS0700334 *	B1	40/50	1 1/4	Fusion weld connection, "high" version <i>Schweissverbindung, „hohe“ Version</i>	5	40	400	970x800x1200	SF01	29,57
VS0700332 *	B1	40/50	1 1/2	Fusion weld connection, "high" version <i>Schweissverbindung, „hohe“ Version</i>	5	40	400	970x800x1200	SF01	24,26
VS0700105	C1	40	1 1/2	Nut and ring connection, "low" version <i>Schraubverbindung, „niedrige“ Version</i>	10	160	800	970x800x1200	SF01	16,19
VS0700106	C2	40/50	1 1/2	Fusion weld connection, "low" version <i>Schweissverbindung, „niedrige“ Version</i>	10	80	560	970x800x1200	SF01	16,19

Traps for bathtub drainage with swivel connection, nut and flat rubber seal (fibre seal to be used for connection with metal drain available as spare). Models with fusion weld connection available with 40/50 mm dual diameter (extremely useful if diameter of connection pipe is not known before installation) whilst the models with nut ring connection are suitable for any 40 mm pipe.

Badewannenablaufsi-phon mit verstellbarer Anschluss, nuss und Gummiflachedichtung (als Ersatzteil steht die Faserdichtung für die Verbindung an Metallablaufgarnituren zur Verfügung). Die Modelle sind mit Schweissverbindung mit doppeltem Durchmesser 40/50 mm (sehr nützlich, wenn der Durchmesser des Anschlussrohres nicht im Voraus bekannt ist) oder mit Schraubverbindung für alle Arten von Rohrleitungen mit Durchmesser 40 mm erhältlich.

* Welded. - Abzweiger angeschweißt.

BATHROOM - POP-UP WASTE TRAPS FOR BATHTUBS
 BADEZIMMER - BADEWANNEABLAUFGARNITUREN MIT SIPHON

HDPE/PP traps for bathtub drainage with brass or plastic nut

*Badewannenablaufsi-
phon aus HDPE oder
PP mit Messing- oder
Kunststoffmutter*

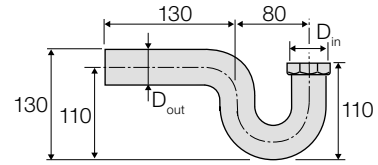

Mod. A1

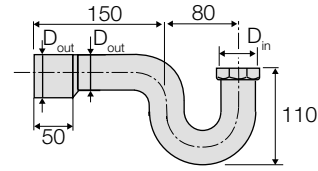

Mod. A2

COD.	Mod.	D _{out}	D _{in}	Material				HxLxP	CL	€/pz
VS0700013 *	A1	40	1"¼	Body in HDPE, brass nut <i>Körper aus Polyethylen (HDPE), Messingmutter</i>	20	160	640	1010x800x1200	SF01	20,88
VS0700015 *	A1	40	1"½	Body in HDPE, brass nut <i>Körper aus Polyethylen (HDPE), Messingmutter</i>	20	160	800	1030x800x1200	SF01	19,01
VS0700018 *	A2	40/50	1"½	Body in HDPE, brass nut <i>Körper aus Polyethylen (HDPE), Messingmutter</i>	20	160	640	1010x800x1200	SF01	19,74
VS0700009 *	A1	40	1"½	Body in HDPE, plastic nut <i>Körper aus Polyethylen (HDPE), Kunststoffmutter</i>	20	160	640	1010x800x1200	SF01	16,78
VS0700138 •	A1	40	1"¼	Body in PP, plastic nut <i>Körper aus Polyethylen (HDPE), Kunststoffmutter</i>	20	160	640	1010x800x1200	SF01	9,72

Traps for bathtub drainage in one piece, made up of polyethylene (HDPE) or polypropylene (PP) with brass or plastic nut depending on the model. A rubber flat seal is supplied; a fibre seal is available as a spare for connection to metal drains and syphons with brass nuts. Models with fusion weld connection available with 40/50 mm dual diameter (extremely useful if diameter of connection pipe is not known before installation) or with 40 mm connection.

*Badewannenablaufsi-
phons aus Polyethylen (HDPE) oder Polypropylen (PP) mit Überwurfmutter aus Messing oder Kunststoff, je nach Modell.
Die Flachdichtung wird aus Gummi geliefert; eine Faserdichtung ist als Ersatzteil für den Anschluss an Metallablaufgarnituren und Siphons mit Messingmutter erhältlich. Die Modelle sind mit Schweißverbindung mit doppeltem Durchmesser 40/50 mm (sehr nützlich, wenn der Durchmesser des Anschlussrohres nicht im Voraus bekannt ist) oder mit Anschluss mit Durchmesser 40 mm erhältlich.*

* Welded. - Abzweiger angeschweißt.

• Sell out. - Ausverkauf.

Spare parts - Ersatzteile

Flat seal

Flachdichtung



COD.	D		CL	€/pz
VS0703024	1"¼	10	SF01	0,87
VS0703021	1"½	10	SF01	0,63

Fibre flat seal

Flachfaserdichtung



COD.	D		CL	€/pz
VS0703029	1"¼	10	SF01	0,58
VS0703027	1"½	10	SF01	0,58

Conic seal

Konische Dichtung



COD.	D		CL	€/pz
VS0703141	32	10	SF01	0,76
VS0703025	40	10	SF01	0,76

BATHROOM - SHOWER TRAY TRAPS

BADEZIMMER - DUSCHWANNENABLAUFSIPHONS

T-58

PP shallow trap for shower trays, D 90

Superflacher Siphon aus PP für Duschwannen D 90

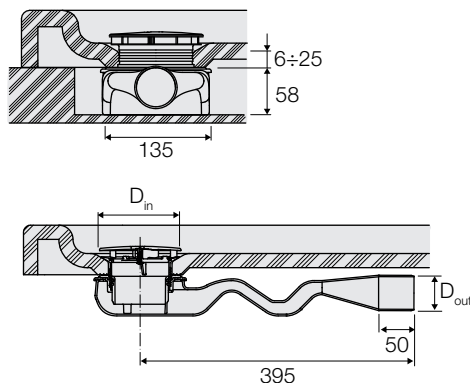

COD.	D _{out}	D _{in}	Shower tray hole D Loch für Duschwanne	Connection Verbindung				HxLxP	CL	€/pz
VS0700291	50	115	90	Horizontal	1	12	96	1120x800x1200	SF01	100,04

Version with PVC adaptor D 50 - Version mit PVC-Muffe D 50

COD.	D _{out}	D _{in}	Shower tray hole D Loch für Duschwanne	Connection Verbindung				HxLxP	CL	€/pz
VS0700293	50	115	90	Horizontal	1	12	96	1120x800x1200	SF01	104,58

Drains for shower tray, trapped and inspectable, suitable for shower trays with 90 mm diameter hole and supplied with cover in polished chrome ABS. The generous bore passage and double water seal guarantees excellent drainage performance, foul odour resistance and accessibility for cleaning.

Duschwannenabläufe, mit Siphon inspektionierbar, geeignet für Duschwannen mit 90 mm Lochdurchmesser und mit polierter, verchromte ABS-Abdeckhaube. Der großzügige Durchgangsbereich und die doppelte hydraulische Schutzvorrichtung garantieren eine hervorragende Abflulleistung, Geruchshemmung und Zugänglichkeit zur Reinigung.

Spare parts - Ersatzteile

Conveyor for shallow trap with o-ring

Siphoneinsatz mit O-Ring für superflachen Siphon



COD.		CL	€/pz
VS0701637	1	SF01	6,43

Flat seal for shallow trap

Flachdichtung für superflachen Siphon

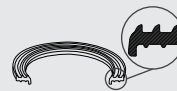

COD.		CL	€/pz
VS0701621	1	SF01	3,39

For ceramic shower trays. - Für Keramik-Duschwannen.

Spare parts - Ersatzteile

Conic seal for shallow trap

Konische Dichtung für superflachen Siphon



COD.		CL	€/pz
VS0701626	1	SF01	3,28

For shower trays in fiberglass and steel. - Für Duschwannen aus Acryl und Stahl.

1-lip seal for shallow trap

Dichtung mit Oberlippe für superflachen Siphon



COD.		CL	€/pz
VS0701649	1	SF01	14,40

Double seal For ceramic shower trays. - Doppeldichtung für Keramik-Duschwannen.

Chrome cover with adaptor for shallow trap

Verchromter Stopfen mit Adapter für superflachen Siphon



COD.		CL	€/pz
VS0701629	1	SF01	14,47

Screw for shallow trap

Verschraubung für superflachen Siphon

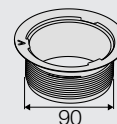

COD.		CL	€/pz
VS0701622	1	SF01	4,09

3V TRAP
Shower tray trap,
D 90, with water seal
and metal ring nut

*Ablaufsiphon für
Duschwanne D 90, mit
Sperrwassereinsatz und
Metallring*

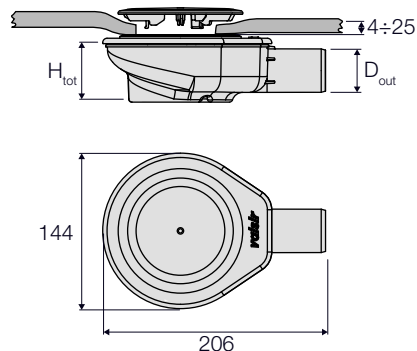

COD.	H hydraulic seal H Wasservorlage	H _{tot}	Shower tray hole D Loch für Duschwanne	D _{out}	L ₁	L ₂		CL	€/pz
VS0701220	30	58	90	40	206	144	8	SF01	100,50
VS0701221	50	75	90	50	206	144	8	SF01	100,50

Available from June 2022. - Ab Juni 2022 erhältlich.

Spare parts - Ersatzteile

Hydraulic seal for 3V trap

Wasservorlage für Ablaufsiphon 3V



COD.	H		CL	€/pz
VS0701230	30	1	SF01	19,70
VS0701231	50	1	SF01	21,80

Available from June 2022. - Ab Juni 2022 erhältlich.

Conveyor for 3V trap

Förderanlage für Siphon 3V



COD.	H		CL	€/pz
VS0701232	30	1	SF01	4,05
VS0701233	50	1	SF01	4,15

Available from June 2022. - Ab Juni 2022 erhältlich.

Flat seal for 3V trap

Flachdichtung für Siphon 3V



COD.		CL	€/pz
VS0701234	1	SF01	7,05

Available from June 2022. - Ab Juni 2022 erhältlich.

Spare parts - Ersatzteile

**Chrome-plated cap
for 3V trap**

Chromstopfen für Siphon 3V





COD.		CL	€/pz
 VS0701235	1	SF01	28,00

Available from June 2022. - *Ab Juni 2022 erhältlich.*

**Metal ring nut with screws
for 3V trap**

*Metallring mit Schrauben für
Siphon 3V*



COD.		CL	€/pz
 VS0701236	1	SF01	18,30

Available from June 2022. - *Ab Juni 2022 erhältlich.*

Inspectable trap for shower tray, swivel connection

Duschabflusssiphon, inspektionierbar, schwenkbarer Anschluss

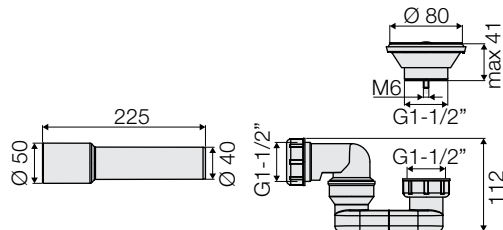

COD.		CL	€/pz
VS0700198	5	SF01	16,61

Spare parts - Ersatzteile

Round stainless steel grating with screws

Edelstahl-Rundrost komplett mit Schraube



COD.		CL	€/pz
VS0703130	1	SF01	4,81

Shower tray trap, with water seal

Siphon für Duschwanne, mit Sperrwassereinsatz

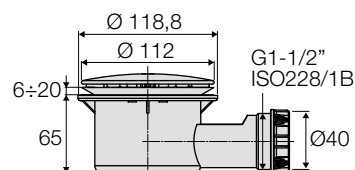

COD.		CL	€/pz
VS0700345	5	SF01	32,35

Shower tray trap, with water seal, with connector

Siphon für Duschwanne, mit Sperrwassereinsatz und Büchse

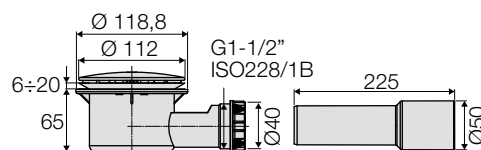
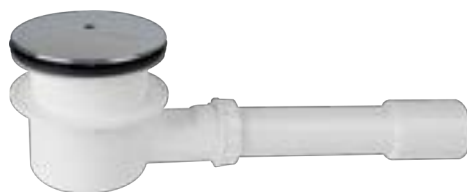

COD.		CL	€/pz
VS0700346	5	SF01	33,91

PP drain for shower tray, trapped and inspectable, with vertical or horizontal swivel connection

Ablaufgarnitur aus PP für Duschabfluss, komplett mit Siphon inspektionsfähig, vertikaler oder horizontaler Abgang

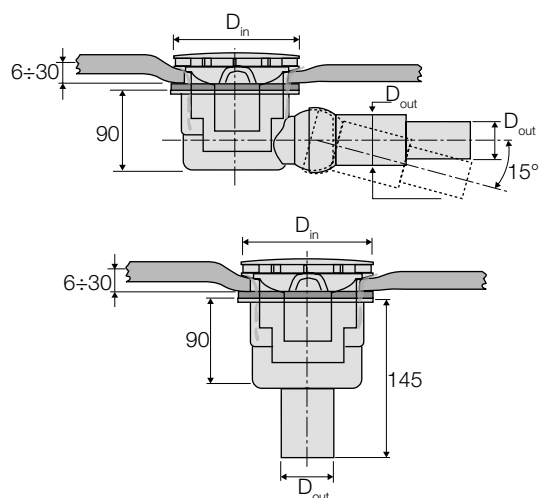

COD.	D _{out}	D _{in}	Shower tray hole D Loch für Duschwanne	Connection Verbindung		CL	€/pz
VS0700287	50/40	115	90	PP Swivel horizontal Horizontal verstellbar, PP	5	SF01	64,08
VS0700289	51/46	115	90	PVC Swivel horizontal Horizontal verstellbar, PVC	5	SF01	64,08
VS0700285	50	115	90	PP Vertical - Vertikal, PP	5	SF01	61,15

Drains for shower tray, trapped and inspectable, suitable for shower trays with 90 mm diameter hole and supplied with cover in polished chrome ABS and flat seal. Models are available with vertical connection or horizontal swivel connection (0 to 15°) with dual diameter. The version with ABS connection is suitable for connection to solvent weld PVC pipes as well.

Duschwannenabläufe mit inspektionsfähigem Siphon, geeignet für Duschwannen mit 90 mm Lochdurchmesser und ausgestattet mit polierter verchromter ABS-Abdeckhaube und Flachdichtung. Es sind Modelle mit vertikalem oder horizontal verstellbarem Abgang (0÷15°) mit doppeltem Durchmesser erhältlich. Die Version mit ABS-Anschluss ist für die Verbindung an PVC-Rohrleitungen mit Verklebung geeignet.

Spare parts - Ersatzteile

Cover for trap with conveyor

Stopfen für Siphon mit Siphoneinsatz



COD.	Colour - Farbe		CL	€/pz
VS0701659	polished chrome - Chrom poliert	1	SF01	18,54

Flat seal, diameter 90 mm

Flachdichtung für Siphon D 90



COD.		CL	€/pz
VS0701618	1	SF01	3,17

For ceramic shower trays. - Für Keramik-Duschwannen.

Spare parts - Ersatzteile

**Conic seal, diameter
 90 mm**
*Konische Dichtung für Siphon
 D 90*



COD.		CL	€/pz
VS0701619	1	SF01	3,41

For shower trays in fiberglass and steel. - Für Duschwannen aus Acryl und Stahl.

Conveyor
Siphoneinsatz

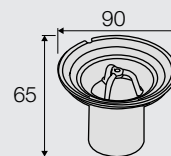

COD.		CL	€/pz
VS0700443	1	SF01	6,70

Basket
Korb



COD.		CL	€/pz
VS0700446	1	SF01	7,17

HDPE trap for shower tray, fully inspectable

Duschwannenablauf-siphon komplett aus HDPE, inspektionierbar

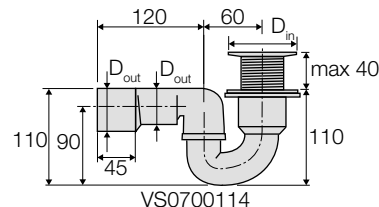
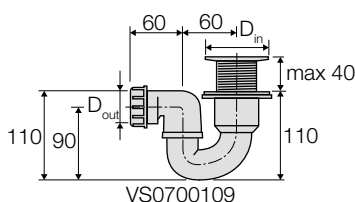

COD.	D _{out}	D _{in}	Shower tray hole D Loch für Duschwanne	Type - Typ				HxLxP	CL	€/pz
VS0700109	40	80	50	Threaded connection Schraubverbindung	5	80	400	970x800x1200	SF01	34,34
VS0700114	40/50	80	50	Fusion weld Schweissverbindung	5	40	280	970x800x1200	SF01	34,34

HDPE traps suitable for shower trays with 50 mm diameter hole and metal drains, provided with round chrome grating and removable plastic strainer. Models are available in two version: with fusion weld connection featuring 40/50 mm dual diameter (extremely useful if diameter of connection pipe is not known before installation) or with 40 mm diameter nut and ring connection (for use with any type of pipe).
 Komplette Duschwannenablauf-siphons aus Polyethylen (HDPE), geeignet für Duschwannen mit einem Lochdurchmesser von 50 mm und ausgestattet mit einer Metallablaufgarnitur, einem runden verchromten Anlaufrost und abnehmbarem Kunststoffkorb. Sie sind mit einer Schweissverbindung mit doppeltem Durchmesser von 40/50 mm (sehr nützlich, wenn der Durchmesser des Anschlussrohrs nicht im Voraus bekannt ist) oder mit einer Schraubverbindung mit 40 mm Durchmesser (für den Einsatz mit jedem Rohrtyp) ausgestattet.

Spare parts - Ersatzteile

Flat seal
 Flachdichtung

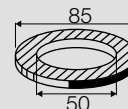

COD.		CL	€/pz
VS0703131	1	SF01	1,67

Chrome grating with strainer
 Verchromter Ablaufrost komplett mit Korb



COD.		CL	€/pz
VS0703038	1	SF01	20,96

For codes - Für ART.-NR. VS0700168-VS0700169-VS0700109-VS0700114.

HDPE trap for shower tray, fully inspectable, swivel connection

Duschwannenablauf-siphon komplett aus HDPE, inspektionierbar, schwenkbarer Anschluss

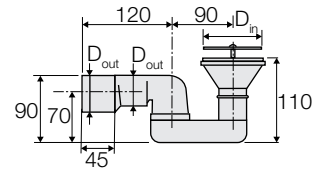

COD.	D _{out}	D _{in}	Type - Typ				HxLxP	CL	€/pz
VS0700049	40/50	80	Fusion weld connection, "low version" Schweissverbindung, „niedrige“ Version	5	40	280	970x800x1200	SF01	23,17

HDPE swivel traps for shower trays with round stainless steel grating. Models with fusion weld connection available with 40/50 mm dual diameter (extremely useful if diameter of connection pipe is not known before installation).

Komplette verstellbare Duschwannenablauf-siphons aus Polyethylen (HDPE) und ausgestattet mit einem runden Edelstahlrost. Die Modelle sind mit doppeltem Durchmesser 40/50 mm Schweissverbindung (sehr nützlich, wenn der Durchmesser des Anschlussrohres nicht im Voraus bekannt ist).

Spare parts - Ersatzteile

Round stainless steel grating with screws

Edelstahl-Rundrost komplett mit Schraube



COD.		CL	€/pz
VS0703129	1	SF01	4,71

Flat seal

Flachdichtung

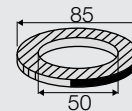

COD.		CL	€/pz
VS0703131	1	SF01	1,67

Drain for shower tray, trapped and fully inspectable

Duschwannenablaufsiphon komplett, inspektionierbar

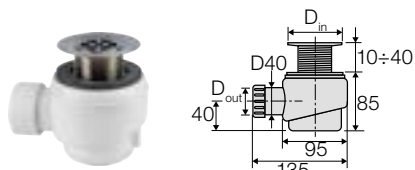

Mod. A1

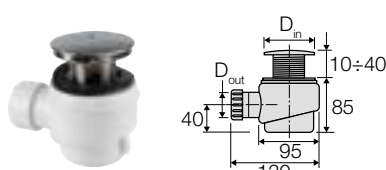

Mod. A2

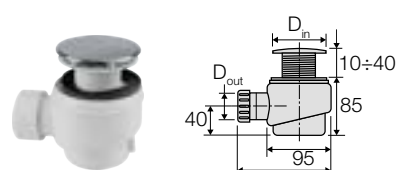

Mod. A3



Mod. B1

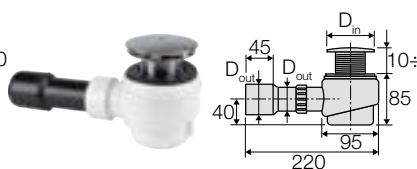

Mod. B2

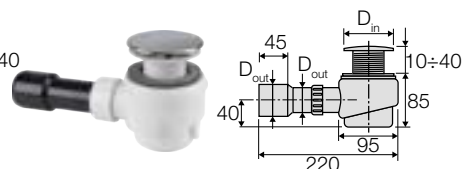

Mod. B3

COD.	Mod.	D _{out}	D _{in}	Shower tray hole D Loch für Duschwanne	Type - Typ				HxLxP	CL	€/pz
VS0700168	A1	40/50	80	50	Chrome grating Verchromter Rost	5	80	400	970x800x1200	SF01	32,83
VS0700164	A2	40	84	50	Cover in chrome plated brass Abdeckhaube aus verchromtem Messing	5	40	280	970x800x1200	SF01	41,71
VS0700170	A3	40	80	50	Cover in chrome plated ABS Abdeckhaube aus verchromtem ABS	5	40	280	970x800x1200	SF01	27,26
VS0700169	B1	40/50	80	50	Chrome grating Verchromter Rost	5	40	280	970x800x1200	SF01	35,58
VS0700165	B2	40/50	84	50	Cover in chrome plated brass Abdeckhaube aus verchromtem Messing	5	40	280	970x800x1200	SF01	45,39
VS0700167	B2	40/50	84	50	Cover plate made of golden brass Abdeckplatte aus goldfarbenem Messing	5	40	280	970x800x1200	SF01	52,66
VS0700171	B3	40/50	80	50	Cover in chrome plated ABS Abdeckhaube aus verchromtem ABS	5	40	280	970x800x1200	SF01	31,31

Drains for shower trays, trapped and inspectable suitable for shower trays with 50 mm diameter holes. Depending on the model, they have strainer and chrome grating, cover in chrome or gold plated brass, in chrome plated ABS. Models are available with nut and ring connection to connect to any type of 40 mm pipe are available or in fusion weld HDPE with dual diameter 40/50 mm (extremely useful when diameter of connection pipe is not known before installation).

Duschwannenablaufsiphon, inspektionierbar, geeignet für Duschwannen mit 50 mm Lochdurchmesser. Je nach Modell mit verchromtem Rost und Korb, verchromter oder vergoldeter Abdeckhaube aus Messing oder verchromtem ABS ausgestattet. Die Modelle sind mit Schraubverbindung für den Anschluss aller Arten von Rohrleitungen mit einem Durchmesser von 40 mm oder mit HDPE-Schweißschaft mit einem Doppeldurchmesser von 40/50 mm erhältlich (sehr nützlich, wenn der Durchmesser des Anschlussrohrs nicht bekannt ist).

Spare parts - Ersatzteile

Flat seal
 Flachdichtung

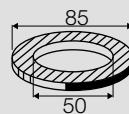

COD.		CL	€/pz
VS0703131	1	SF01	1,67

Chrome grating with strainer
 Verchromter Ablaufrost komplett mit Korb



COD.		CL	€/pz
VS0703038	1	SF01	20,96

For codes - Für ART.-NR. VS0700168-VS0700169-VS0700109-VS0700114.

TRAPS
 ABLAUFSIPHONS



TRAPS AND CONNECTORS FOR URINAL

URINALABLAUFSIPHON

Traps for urinals

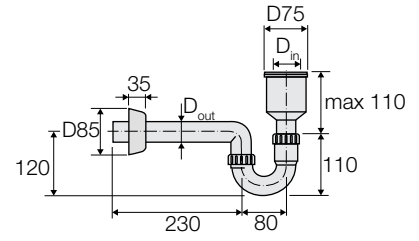
Urinalablaufsiphon



COD.	D _{out}	D _{in}				HxLxP 	CL	€/pz
VS0700227	40	50	5	40	200	1030x800x1200	SF01	14,90

Traps and connectors for the urinal in white polypropylene (PP). - *Urinalablaufsiphon aus weißem Polypropylen (PP).*

FLOOR AND TERRACE DRAINS

BODEN-UND TERRASSENABLÄUFE

Shallow trap with 1800x1800 mm sheet or without sheet

Superflacher Siphon aus PP mit Folie 1800x1800 mm und ohne Folie

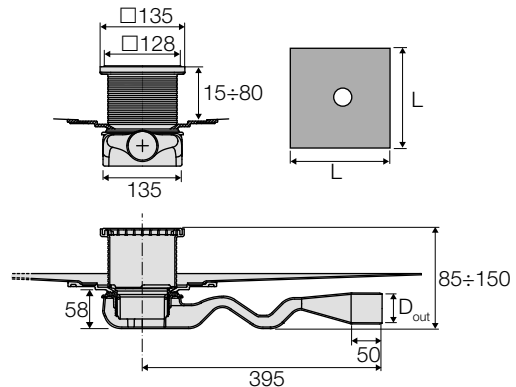

COD.	D _{out}	LxL	Connection Verbindung	Sheet Folie		CL	€/pz
VS0700385	50	1800x1800	Horizontal	With hole - Gelocht	1	SF01	307,78
VS0700388	50	-	Horizontal	No - Nein	1	SF01	122,13

Horizontal gully in PP with a 50 mm diameter outlet characterised by reduced depth: installation depth, including the tiles, varies from a minimum of 85 mm to a maximum of 150 mm. The gully comes with a 128x128 mm stainless steel grating and extension. The gully is supplied with 1 mm thick 1800x1800 mm PVC sheet with hole and flange. The generous bore passage and double water seal guarantees excellent drainage performance, foul odour resistance and accessibility for cleaning. The trap is suitable for use with a single shower. N.B. Trap compatible with the 128x128 mm Design shower gratings.

Horizontaler Abflussschacht aus PP mit Abgangsdurchmesser von 50 mm, gekennzeichnet durch eine reduzierte Stärke: Die Einbauhöhe einschließlich der Fliesen reicht von mindestens 85 mm bis maximal 150 mm. Komplett mit Edelstahlrost 128x128 mm und Verlängerung. Er wird komplett mit PVC-Folie 1 mm dick, 1800x1800 mm, gelocht und geflanscht geliefert. Der großzügige Durchgangsbereich und die doppelte hydraulische Schutzvorrichtung garantieren eine hervorragende Abflussleistung, Geruchshemmung und Zugänglichkeit zur Reinigung und ermöglichen den Einsatz mit nur einem Ablauf. HINWEIS Siphon kompatibel mit 128x128 mm Rosten der Linie Design.

Spare parts - Ersatzteile

128x128 mm stainless steel grating

Edelstahlrost 128x128 mm



COD.		CL	€/pz
VS0703135	1	SF01	8,80

Extension with 135x135 mm stainless steel grating

Verlängerung mit Edelstahlrost 135x135 mm

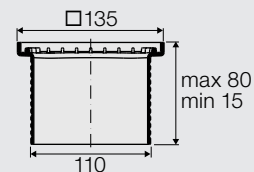

COD.		CL	€/pz
VS0701660	1	SF01	15,56

Compatible with the 128x128 mm Design shower gratings. - Für Design Roste 128x128 mm.

Conveyor for shallow trap with o-ring

Siphoneinsatz mit O-Ring für superflachen Siphon



COD.		CL	€/pz
VS0701637	1	SF01	6,43

Spare parts - Ersatzteile

Screw for shallow trap with centering extension

Verschraubung für superflachen Siphon mit Zentrierung für Verlängerung



COD.		CL	€/pz
VS0701625	1	SF01	4,01

Flange

Flansch



COD.		CL	€/pz
VS0701510	1	SF01	13,95

Flat seal for shallow trap

Flachdichtung für superflachen Siphon



COD.		CL	€/pz
VS0701621	1	SF01	3,39

PVC sheet with hole and flange

Gelochte und geflanschte PVC-Folie

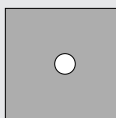

COD.	LxL				HxLxP	CL	€/pz
VS0701525	1200x1200	1	8	56	970x800x1200	SF01	99,36
VS0701527	1800x1800	1	8	56	970x800x1200	SF01	184,25

Accessories - Ersatzteile

Blank PVC sheet

PVC-Folie nicht gelocht



COD.	LxL				HxLxP	CL	€/pz
VS0701528	1800x1800	1	8	56	970x800x1200	SF01	116,33

PP shower trap with sheet, outlet D 50

Duschwannenablauf aus PP mit Siphon, mit Dichtfolie, Anschluss D 50

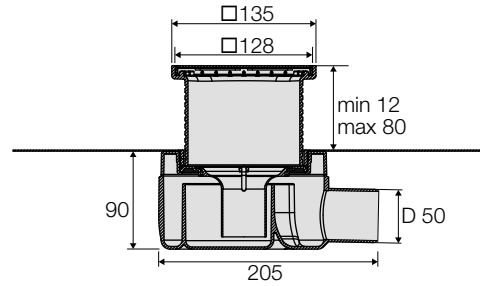

COD.	D _{out}	LxL		CL	€/pz
VS0700435	50	1200x1200	1	SF01	114,40
VS0700437	50	1600x1600	1	SF01	165,40
VS0700439	50	1800x1800	1	SF01	217,78
VS0700441	50	2000x2000	1	SF01	232,94

Floor trap in PP with one 50 mm horizontal outlet. The gully includes stainless steel grating, protective cover and 1 mm thick PVC sheet with ring and seal. PVC sheets with non standard sizes can be supplied on request. The trap is suitable for use with a single shower.

N.B. Trap compatible with the 128x128 mm Design shower gratings

Schachtablauf aus Polypropylen (PP) mit 1 horizontalen Abgang Durchmesser 50 mm. Der Schachtablauf ist komplett mit Edelstahlrost, Schutzstopfen und PVC-Folie, 1 mm dick mit Ring mit Dichtscheibe. Auf Anfrage ist es möglich, PVC-Folien mit Sondermaßen zu liefern. Der Siphon ist für den Einsatz mit nur einem Ablauf geeignet.

HINWEIS Siphon kompatibel mit 128x128 mm Rosten der Linie Design.

Spare parts - Ersatzteile

VS0700429-VS0700431-VS0700433

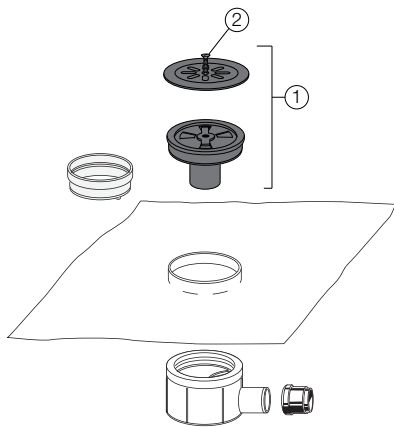

	COD.		CL	€/pz
① Cover with round stainless steel grating Stopfen komplett mit rundem Edelstahlrost	VS0701213	10	SF01	13,47
② Stainless steel screw Edelstahlschraube	VS0703005	10	SF01	1,06

Spare parts - Ersatzteile

Conveyor
Siphoneinsatz

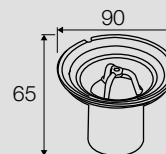

COD.		CL	€/pz
VS0700443	1	SF01	6,70

128x128 mm stainless steel grating
Edelstahlrost 128x128 mm



COD.		CL	€/pz
VS0703135	1	SF01	8,80

Extension with 135x135 mm stainless steel grating
Verlängerung mit Edelstahlrost 135x135 mm

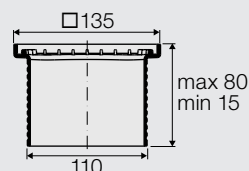

COD.		CL	€/pz
VS0701660	1	SF01	15,56

Compatible with the 128x128 mm Design shower gratings. - Für Design Roste 128x128 mm.

Accessories - Ersatzteile

Grid support
Rostrahmen



Mod. A



Mod. B



Mod. C

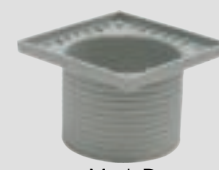

Mod. D

COD.	Mod.	H		CL	€/pz
VS0710311	A	5	1	DS01	27,10
VS0710313	B	9	1	DS01	6,37
VS0710315	C	13	1	DS01	3,89
VS0710317	D	88	1	DS01	6,49

Complete PP floor gully, trapped and inspectable, vertical or swivel horizontal connection
Boden-Abfluss komplett, aus PP, mit Siphon inspektionierbar, vertikaler und horizontaler Anschluss

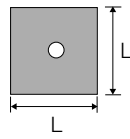

Mod. A

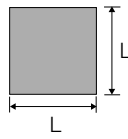

Mod. B

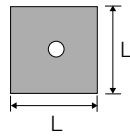
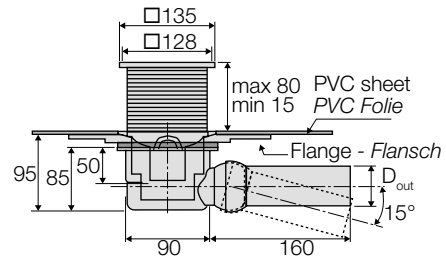

Mod. A

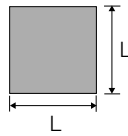

Mod. B

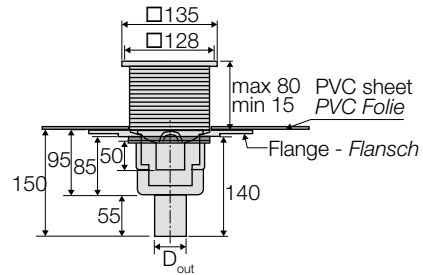

COD.	Mod.	D _{out}	LxL Sheet LxL Folie	Connection Verbindung	Sheet Folie				HxLxP	CL	€/pz
VS0700360	A	50	1200x1200	Swivel horizontal Horizontal verstellbar	With hole Gelocht	1	8	40	1030x800x1200	SF01	152,06
VS0700361	A	50	1600x1600	Swivel horizontal Horizontal verstellbar	With hole Gelocht	1	8	40	1030x800x1200	SF01	210,83
VS0700362	A	50	1800x1800	Swivel horizontal Horizontal verstellbar	With hole Gelocht	1	8	40	1030x800x1200	SF01	267,98
VS0700370	A	50	1200x1200	Vertical - Vertikal	With hole Gelocht	1	8	40	1030x800x1200	SF01	152,06
VS0700371	A	50	1600x1600	Vertical - Vertikal	With hole Gelocht	1	8	40	1030x800x1200	SF01	210,83
VS0700365	B	50	1800x1800	Swivel horizontal Horizontal verstellbar	Blank Nicht Gelocht	1	8	40	1030x800x1200	SF01	257,69
VS0700375	B	50	1800x1800	Vertical - Vertikal	Blank Nicht Gelocht	1	8	40	1030x800x1200	SF01	257,69
VS0700368	-	50	-	Swivel horizontal Horizontal verstellbar	-	1	8	40	1030x800x1200	SF01	86,55
VS0700377	-	50	-	Vertical - Vertikal	-	1	8	40	1030x800x1200	SF01	86,55

PP gully with one 50 mm outlet that, depending on the model, can provide a swivel horizontal (0 to 15°) or a vertical connection. The gully comes with a 128x128 mm stainless steel grating and 90 mm riser. The extension can be supplied with a PVC sheet with (1 mm thick) with hole and flange or a PVC blank sheet and flange to be glued during installation. The trap is suitable for use with a single shower.

Schachtablauf aus PP bestehend aus 1 Anschluss mit Durchmesser 50 mm, das je nach Modell horizontal (0-15°) oder vertikal verwendet werden kann. Der Schachtablauf ist komplett mit 128x128 mm Edelstahlrost und Verlängerung 90 mm Nutzhöhe. Der Schachtablauf kann mit PVC-Folie 1 mm dick, gelocht und geflanscht oder mit PVC-Folie nicht gelocht und mit Flansch zum Verkleben bei der Montage geliefert werden.

Spare parts - Ersatzteile

Extension with 135x135 mm stainless steel grating

Verlängerung mit Edelstahlrost
135x135 mm

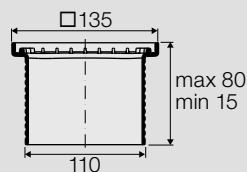

COD.		CL	€/pz
VS0701660	1	SF01	15,56

Compatible with the 128x128 mm Design shower gratings. - Für Design Roste 128x128 mm.

128x128 mm stainless steel grating

Edelstahlrost 128x128 mm



COD.		CL	€/pz
VS0703135	1	SF01	8,80

PVC sheet with hole and flange

Flansch für PVC-Folie nicht gelocht

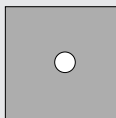

COD.	LxL				HxLxP	CL	€/pz
VS0701525	1200x1200	1	8	56	970x800x1200	SF01	99,36
VS0701527	1800x1800	1	8	56	970x800x1200	SF01	184,25

Blank PVC sheet

PVC-Folie nicht gelocht



COD.	LxL				HxLxP	CL	€/pz
VS0701528	1800x1800	1	8	56	970x800x1200	SF01	116,33

Flange

Flansch



COD.		CL	€/pz
VS0701510	1	SF01	13,95

Spare parts - Ersatzteile

Conveyor
Siphoneinsatz

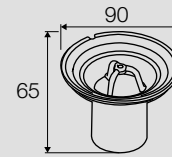

COD.		CL	€/pz
VS0700443	1	SF01	6,70

Basket
Korb



COD.		CL	€/pz
VS0700446	1	SF01	7,17

Flat seal, diameter 90 mm
Flachdichtung für Siphon D 90



COD.		CL	€/pz
VS0701618	1	SF01	3,17

Accessories - Ersatzteile

Grid support
Rostrahmen



Mod. A



Mod. B



Mod. C



Mod. D

COD.	Mod.	H		CL	€/pz
VS0710311	A	5	1	DS01	27,10
VS0710313	B	9	1	DS01	6,37
VS0710315	C	13	1	DS01	3,89
VS0710317	D	88	1	DS01	6,49

T-TRAP

Triplus gully, trapped and accessible, vertical and horizontal connections

Triplus Ablauf mit Siphon inspektionierbar, senkrechten und waagrechten Anschlüssen

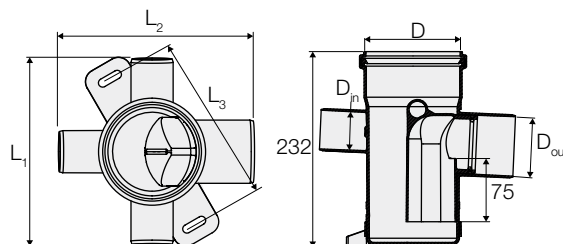

COD.	D	D _{in}	D _{out}	L ₁	L ₂	L ₃				HxLxP	CL	€/pz
VS0701741	110	3x50	1x75	220	230	200	5	20	60	955x800x1200	SF01	43,31

Gully trap with water seal consisting of an upper inlet diameter 110 mm with socket and sealing gasket, 3 side inlets (closed and prearranged for drilling) and 1 side outlet. 75 mm water seal realized through a removable insert with 100 mm removal space. Supplied complete with adjustable lower support for ceiling mounting.

Siphon-Schachtrohr bestehend aus einem oberen Einlauf, Durchmesser 110 mm, mit Muffe und Dichtung, 3 seitlichen Einläufen (die blind und für die Bohrung ausgelegt sind) und 1 seitlichen Auslauf. Geruchsverschluss, 75 mm, bestehend aus herausnehmbarem Einsatz, 100 mm Platzbedarf für das Entfernen. Lieferung samt unterem, schwenkbarem Halter zur Deckenmontage.

Triplus Trap H 170 mm, fully inspectable with horizontal and vertical connection

Triplus Ablauf H 170 mm mit Siphon inspektionierbar, senkrechten und waagrechten Anschlüssen

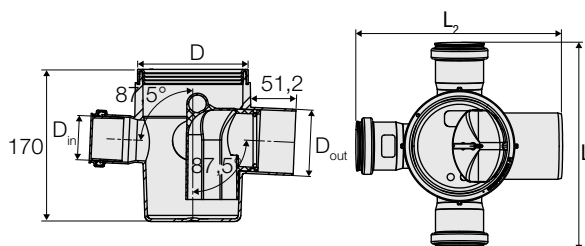

COD.	D	D _{in}	D _{out}	L ₁	L ₂				HxLxP	CL	€/pz
VS0701743	110	3x50	1x75	232	232	5	20	60	955x800x1200	SF01	34,49

Gully trap with water seal consisting of an upper inlet diameter 110 mm with sealing gasket, 3 side inlets (socket and gasket) and 1 side outlet. 50 mm water seal realized through a removable insert with 100 mm removal space.

Siphon-Schachtrohr bestehend aus einem oberen Einlauf, Durchmesser 110 mm, mit Dichtung, 3 seitlichen Einläufen (Muffe und Dichtung) und 1 seitlichen Auslauf. Geruchsverschluss, 50 mm, bestehend aus herausnehmbarem Einsatz, 100 mm Platzbedarf für das Entfernen.

Spare parts - Ersatzteile

Water seal

Sperwassereinsatz

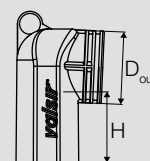

COD.	D _{out}	H		CL	€/pz
VS0701702 *	75	75	1	SF01	5,95
VS0701709 **	75	50	1	SF01	5,33

* For code - Für ART.-NR. VS0701741.

** For code - Für ART.-NR. VS0701743.

Accessories - Ersatzteile

Blank PVC sheet
PVC Folie ohne Löcher



COD.	LxL				HxLxP	CL	€/pz
VS0701528	1800x1800	1	8	56	970x800x1200	SF01	116,33

Extension
Verlängerung

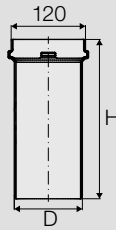

Mod. A



Mod. B

COD.	D	H	Mat.	Mod.		CL	€/pz
VS0701031	110	500	PP	A	1	SF01	9,91
VS0701032	110	150	PP	A	1	SF01	7,20
VS0701028	110	400	PVC	A	1	SF01	9,91
VS0701035 •	110	500	PVC	B	1	SF01	11,48

• Sell out. - Ausverkauf.

Extension with 135x135 mm stainless steel grating

Verlängerung mit Edelstahlrost
135x135 mm

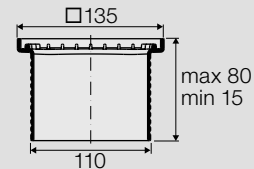

COD.		CL	€/pz
VS0701660	1	SF01	15,56

Compatible with the 128x128 mm Design shower gratings. - Für Design Roste 128x128 mm.

For code. - Für ART.-NR. VS0701035.

Cartable stainless steel with seal

Begehbarer Edelstahlrost mit
Dichtung



Mod. A

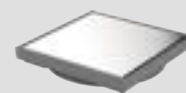

Mod. B

COD.	Mod.				HxLxP	CL	€/pz
VS0701205 *	A	15	240	1200	970x800x1200	SF01	12,27
VS0701207	B	15	240	1200	970x800x1200	SF01	12,90

* Compatible with the 128x128 mm Design shower gratings. - Für Design Roste 128x128 mm.

For codes. - Für ART.-NR. VS0701028-VS0701031-VS0701032. Can also be used without extension. - Kann auch ohne Erweiterung verwendet werden.

Accessories - Ersatzteile

Grid support

Rostrahmen



Mod. A



Mod. B



Mod. C

COD.	Mod.	H		CL	€/pz
VS0710311	A	5	1	DS01	27,10
VS0710313	B	9	1	DS01	6,37
VS0710315	C	13	1	DS01	3,89

Complete PP floor gully, trapped and inspectable, push-fit connections

Boden-Schachtablauf komplett, aus PP, mit Siphon inspektionierbar, Anschlussstutzen

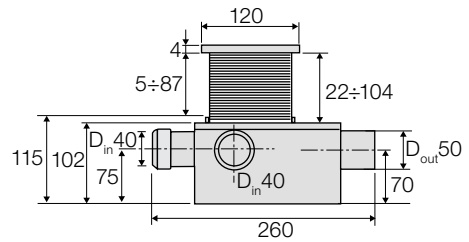

COD.	D _{out}	D _{in}				HxLxP	CL	€/pz
VS0701401	50	3x40	10	40	80	940x800x1200	SF01	56,81

Inspectable trapped gully in polypropylene and made up of 3 40 mm inlets with sockets and two lips rubber rings and 1 50 mm outlet. The gully is provided with a device with back-flow preventing valve (anti-foam/anti-cockroach), the water seal of the extension is provided via an o-ring. The gully comes with a 120x120 mm stainless steel grating and extension.

Inspektionierbarer Siphon aus Polypropylen, bestehend aus 4 Anschlüssen mit 40 mm Durchmesser mit Stutzen und Dichtung und 1 Abgang mit 50 mm Durchmesser. Das Schachtablauf ist mit einer Vorrichtung mit Rückstauverschluss (Antischaum/Antischaben) ausgestattet und die Verbindung mit der Verlängerung erfolgt über eine integrierte Dichtung. Er ist komplett mit 120x120 mm Edelstahlrost und Verlängerung.

Spare parts - Ersatzteile

Extension
Verlängerung

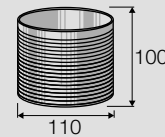

COD.		CL	€/pz
VS0701455	10	SF01	8,00

O-ring for extension
O-Ring für Verlängerung

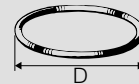

COD.		CL	€/pz
VS0701473	10	SF01	0,81

D 40 single lip rubber ring
Einlippendichtung D 40



COD.	D		CL	€/pz
VS0391003	40	50	CC01	0,45

Spare parts - Ersatzteile

Device with back flow preventing valve (anti-foam/anti-cockroach)

*Ablauf mit Rückstauverschluss
 (Antischaum/Antischaben)*



COD.		CL	€/pz
VS0701458	10	SF01	5,52

HTM Cap

HTM Muffenstopfen



COD.	D				HxLxP	CL	€/pz
VS0524001	40	40	800	5600	935x800x1200	PP02	1,25

Rubber access cap

Gummi-Inspektionsstopfen



COD.		CL	€/pz
VS0701465	10	SF01	1,29

Chrome plated brass round grating 120x120 mm

*Vierkantiger Rost aus
 poliertem, verchromtem
 Messing 120x120 mm*

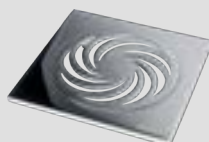

COD.				HxLxP	CL	€/pz
VS0701468	30	240	2400	970x800x1200	SF01	35,01

**Floor gully PP,
inspectable, inlets
with compression
type joint**

*Boden-Schachtablauf
aus PP, inspektionierbar,
Schraubverbindung*

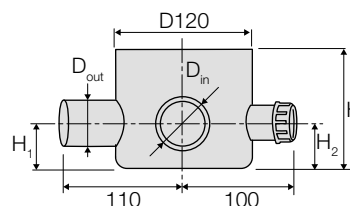

COD.	D _{out}	D _{in}	H	H ₁	H ₂				HxLxP	CL	€/pz
VS0701011	50	4x40	100	40	40	10	40	120	970x800x1200	SF01	11,84
VS0701015	50	4x40	145	40	40	10	40	120	1039x800x1200	SF01	12,60

Inspectable gully in polypropylene made up of four 40 mm inlets and either a 50 mm outlet depending on the version. The gully includes a top protective cap, 2 blank caps, 4 ring nuts and 4 conic seals for inlet connections.

Inspektionierbarer Siphon aus Polypropylen, bestehend aus 4 Anschlüssen mit 40 mm Durchmesser und 1 Abgang mit Durchmesser 50 mm, je nach Modell. Das Schachtablauf ist komplett mit oberem Schutzstopfen, 2 Blindstopfen, 4 Ringmuttern und 4 konischen Dichtungen zur Erstellung der Eingangsanschlüsse.

**Floor gully PP,
trapped and
inspectable, inlets
with compression
type joint**

*Boden-Schachtablauf
aus PP, mit Siphon
inspektionierbar, Schraub-
verbindung*

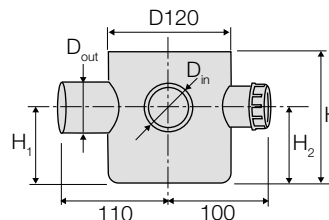

COD.	D _{out}	D _{in}	H	H ₁	H ₂				HxLxP	CL	€/pz
VS0701050	50	4x40	125	135	75	10	40	280	2251x800x1200	SF01	13,36
VS0701075	75	4x40	125	135	75	10	70	280	2251x800x1200	SF01	15,67

Inspectable trapped gully in polypropylene made up of four 40 mm inlets and either a 50 mm or 75 mm outlet depending on the version. The gully includes a top protective cap, 2 blank caps, 4 ring nuts and 4 conic seals for inlet connections. The gullies with codes VS0701050 and VS0701075 are provided with removable trap (Codes VS0701150 and VS0701175) with o-ring seal (Codes VS0701350 and VS0701019) and connection with the extension (optional) is made via a conic seal (VS0701033).

Inspektionierbarer Siphon aus Polypropylen, bestehend aus 4 Anschlüssen mit 40 mm Durchmesser und 1 Abgang mit Durchmesser 50 mm oder 75 mm, je nach Modell. Der Schachtablauf ist komplett mit oberem Schutzstopfen, 2 Blindstopfen, 4 Ringmuttern und 4 konischen Dichtungen zur Erstellung der Eingangsanschlüsse. Die Schachtabläufe mit ART.-NR. VS0701050 und VS0701075 sind mit einem abnehmbaren Siphon ausgestattet (ART.-NR. VS0701150 und VS0701175) mit Dichtung durch O-Ring (ART.-NR. VS0701350 und VS0701019) und die Verbindung mit der Verlängerung (optional) erfolgt über eine Dichtung (ART.-NR. VS0701033).

Spare parts - Ersatzteile

Water seal D 50 - D 75
*Hydraulische Schutzvorrich-
tung D 50 - D 75*

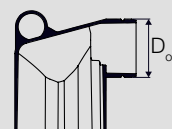

COD.	D _{out}		HxLxP	CL	€/pz
VS0701150	50	10	-	SF01	1,82
VS0701175	75	15	970x800x1200	SF01	2,63

For codes - Für ART.-NR. VS0701050-VS0701075.

Spare parts - Ersatzteile

O-ring for D 50 - D 75 traps

O-Ring für Siphon D 50 - D 75



COD.	D		CL	€/pz
VS0701350	50	10	SF01	0,46
VS0701019	75	10	SF01	0,72

Ring nut

Gewindingmutter



COD.	D		CL	€/pz
VS0701021	40	10	SF01	1,05

Blank plug

Blindstopfen



COD.	D		CL	€/pz
VS0701023	40	10	SF01	0,87

Conic seal

Konische Dichtung



COD.	D		CL	€/pz
VS0701025	40	10	SF01	0,58

Accessories - Ersatzteile

Extension

Verlängerung

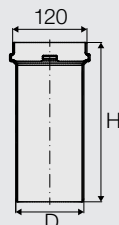

Mod. A

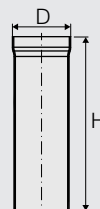

Mod. B

COD.	D	H	Mat.	Mod.		CL	€/pz
VS0701031	110	500	PP	A	1	SF01	9,91
VS0701032	110	150	PP	A	1	SF01	7,20
VS0701028	110	400	PVC	A	1	SF01	9,91
VS0701035 •	110	500	PVC	B	1	SF01	11,48

• Sell out. - Ausverkauf.

Accessories - Ersatzteile

Seal for extension

Dichtung für Verlängerung

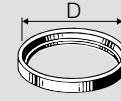

COD.				HxLxP	CL	€/pz
VS0701033	100	800	3200	1010x800x1200	SF01	2,54

Blank cover

Blindstopfen

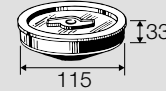

COD.				HxLxP	CL	€/pz
VS0701303	15	240	1200	970x800x1200	SF01	5,75

Cover with blank stainless steel plate

Stopfen komplett mit runder
Edelstahl-Blindplatte

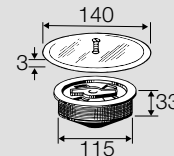

COD.				HxLxP	CL	€/pz
VS0701203	10	160	800	970x800x1200	SF01	11,42

Cover with round stainless steel grating and backflow preventing valve (anti-foam)

Stopfen komplett mit
Rückstauverschluss
(Antischaum)

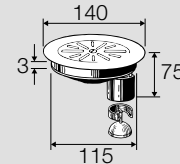

COD.				HxLxP	CL	€/pz
VS0701201	10	80	560	970x800x1200	SF01	12,76

Cover with backflow preventing valve (anti-foam)

Stopfen komplett mit
Rückstauverschluss
(Antischaum)

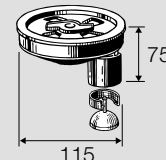

COD.				HxLxP	CL	€/pz
VS0701301	10	160	800	970x800x1200	SF01	7,54

Accessories - Ersatzteile

Stainless steel grid with seal (traffic rated)

Begehbarer Edelstahlrost mit Dichtung



Mod. A



Mod. B

COD.	Mod.				HxLxP	CL	€/pz
VS0701205 *	A	15	240	1200	970x800x1200	SF01	12,27
VS0701207	B	15	240	1200	970x800x1200	SF01	12,90

* Compatible with the 128x128 mm Design shower gratings. - Für Design Roste 128x128 mm.

Antifoam valve

Rückstauventil Antischaum



COD.		CL	€/pz
VS0703045	10	SF01	1,10

Valve grommet

Klammer zum Schließen des Ventils



COD.		CL	€/pz
VS0701305	10	SF01	1,71

**HDPE floor gully,
fusion weld
connections**

*Boden-Schachtablauf
aus HDPE, Schweißver-
bindung*

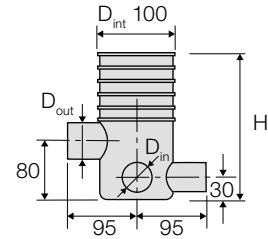

COD.	D _{out}	D _{in}	H				HxLxP	CL	€/pz
VS0700020 •	50	1x40	125	20	80	240	1039x800x1200	SF01	10,24
VS0700021	50	3x40	125	20	80	240	1039x800x1200	SF01	11,06
VS0700025	50	3x40	200	10	40	120	1039x800x1200	SF01	14,80

Gully in HDPE made up of either one or three, 40 mm inlets depending on the version and one 50 mm outlet. The gully includes a top protective cover and the inlets are all closed and must be drilled for use.

Schachtablauf aus Polyethylen, bestehend aus 1 oder 3 Anschlüssen mit einem Durchmesser von 40 mm (je nach Modell) und 1 Abgang mit Durchmesser von 50 mm. Der Schachtablauf ist komplett mit oberem Schutzstopfen und die Einläufe sind mit einem Stopfen versehen. Zur Verwendung müssen sie aufgebohrt werden.

• Sell out. - Ausverkauf.

Spare parts - Ersatzteile

Protective cover

Schutzstopfen

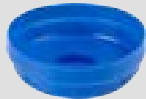

COD.	D	Mat.				HxLxP	CL	€/pz
VS0503100	100	HDPE	10	200	1400	935x800x1200	SF01	1,16

Accessories - Ersatzteile

Cover with round stainless steel grating

*Stopfen komplett mit rundem
Edelstahlrost*

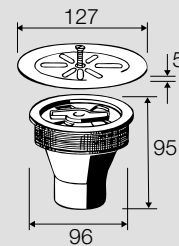

COD.				HxLxP	CL	€/pz
VS0700029	20	160	640	1010x800x1200	SF01	9,24

It can make siphoned the codes - Möglichkeit, folgende ART.-NR. mit Siphon auszustatten VS0700020-VS0700021.

Accessories - Ersatzteile

Cover with blank round stainless steel plate

Stopfen komplett mit runder Edelstahl-Blindplatte

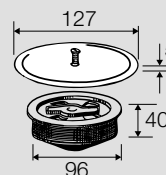

COD.				HxLxP	CL	€/pz
VS0700031	20	160	1120	970x800x1200	SF01	7,78

Cover with stainless steel grating

Stopfen komplett mit bodenbündigem Edelstahlrost

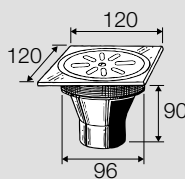

Mod. A

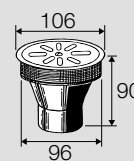

Mod. B

COD.	Mod.	Grating Rost				HxLxP	CL	€/pz
VS0700080	A	□ 120	20	160	480	1015x800x1200	SF01	18,46
VS0700081	B	○ 106	20	160	640	1010x800x1200	SF01	11,99

It can make siphoned the codes - Möglichkeit, folgende ART.-NR. mit Siphon auszustatten VS0700020-VS0700021.

Stainless steel frame 120x120 mm

Edelstahl-Vierkantrahmen 120x120 mm

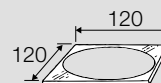

COD.		CL	€/pz
VS0700082	20	SF01	7,62

For code - Für ART.-NR. VS0700080.

Stainless steel screw M6x40

Edelstahlschraube M6x40



COD.		CL	€/pz
VS0703005	10	SF01	1,06

D 106 Round stainless steel grating

Edelstahl-Rundrost D 106



COD.		CL	€/pz
VS0703010	10	SF01	2,65

For codes - Für ART.-NR. VS0700080-VS0700081.

**Trap made of PP,
with water seal and
accessible**

Schachtrohr aus PP,
mit Sperrwassereinsatz
prüfbar



VS0702020

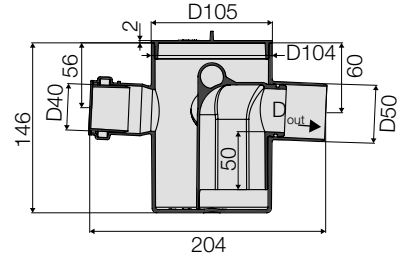

VS0702021

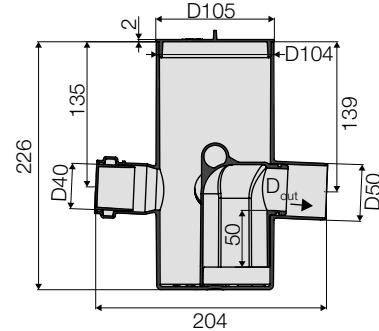

COD.	H	D	D _{in}	D _{out}				HxLxP	CL	€/pz
VS0702020	146	104	3x40	1x50	5	40	120	940x800x1200	SF01	13,10
VS0702021	225	104	3x40	1x50	5	20	60	940x800x1200	SF01	17,97

Trap with water seal made of PP, colour grey, with one upper inlet for cleaning, body diameter 104 mm, 3 side inlet diameters 40 mm, one side outlet diameter 50 mm. The side inlets are fitted with a sealing gasket and blanking cap. The trap is fitted with a 50 mm water seal.

Schachtrohr aus PP mit Siphon, Farbe Grau, mit einem oberen Einlauf zur Reinigung, Körperdurchmesser 104 mm, 3 seitlichen Einläufen Durchmesser 40 mm, einem seitlichen Auslauf mit Durchmesser 50 mm. Die seitlichen Einläufe sind mit einer Dichtung und einem Verschlussstopfen versehen. Das Schlachtrohr ist mit einem Geruchsverschluss, 50 mm, ausgestattet.

**PP shower gully,
trapped and
accessible, with ABS
grid**

Schachtablauf aus PP
für Dusche, mit Siphon
inspektionierbar, mit
ABS-Rost

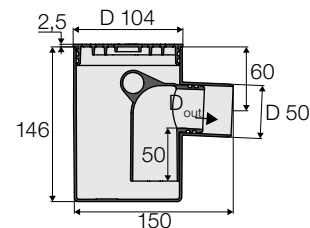

COD.	D	D _{out}	Cap Colour - Stopfenfarbe				HxLxP	CL	€/pz
VS0702001	104	50	pergamon	5	40	160	950x800x1200	SF01	23,25

Trapped shower gully made of PP, grey in colour, composed of a top inlet with diameter 104 mm grid, diameter 50 mm side outlet. The gully has a 50 mm water seal.

Schachtablauf aus PP für Dusche, Farbe grau, bestehend aus einem oberen Einlauf mit Rost mit Durchmesser 104 mm, seitlichem Abgang mit Durchmesser 50 mm. Das Schachtablauf ist mit einer hydraulischen Schutzvorrichtung von 50 mm ausgestattet.

PP gully, trapped and accessible, with ABS blank plug

Schachtablauf aus PP, mit Siphon inspektionierbar, mit Blindstopfen aus ABS

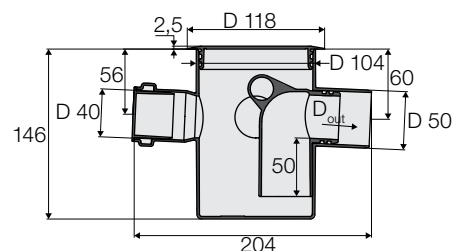

COD.	D	D _{in}	D _{out}	Cap Colour - Stopfenfarbe				HxLxP	CL	€/pz
VS0702002	118	3x40	1x50	pergamon	5	40	120	940x800x1200	SF01	23,25

Trapped gully made of PP, grey in colour, with a top inlet for cleaning, equipped with a blank plug with 2 o-rings that guarantee a tight seal, 104 mm body diameter, 118 mm diameter plug, three 40 mm diameter inlets, and 50 mm side outlet. The side inlets are equipped with rubber seal and cap. The gully has a 50 mm water seal.

Schachtablauf aus PP mit Siphon, Farbe grau, mit einem oberen Einlauf zur Reinigung, ausgestattet mit einem Blindstopfen mit 2 O-Ringen, die seine hermetische Abdichtung gewährleisten, Körperdurchmesser 104 mm, Stopfendurchmesser 118 mm, 3 seitliche Anschlüsse mit Durchmesser 40 mm, einseitiger Abgang mit Durchmesser 50 mm. Die seitlichen Anschlüsse sind mit einer Dichtung und einem Verschlussstopfen versehen. Das Schachtablauf ist mit einer hydraulischen Schutzvorrichtung von 50 mm ausgestattet.

PP inspection gully with horizontal outlet and ABS blank plug

Inspektionsschachtablauf aus PP mit horizontalem Abgang mit Blindstopfen aus ABS

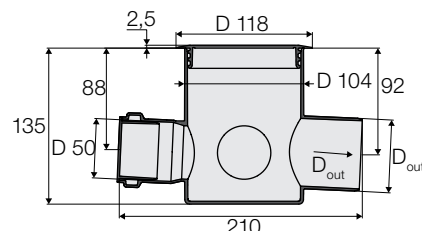

COD.	D	D _{in}	D _{out}	Cap Colour - Stopfenfarbe				HxLxP	CL	€/pz
VS0702003	118	3x50	1x63	pergamon	5	40	120	940x800x1200	SF01	23,25
VS0702013	118	3x50	1x50	pergamon	5	40	120	940x800x1200	SF01	23,25

Inspection gully made of PP, grey in colour, with a top inlet for cleaning, equipped with a blank plug with 2 o-rings that guarantee a tight seal, 104 mm diameter body, three 50 mm diameter side inlets, and 63/50 mm diameter side outlet. The side inlets are equipped with ring seal and cap.

Inspektionsschachtablauf aus PP, Farbe grau, mit einem oberen Einlauf zur Reinigung, ausgestattet mit einem Blindstopfen mit 2 O-Ringen, die die hermetische Abdichtung gewährleisten, Körperdurchmesser 104 mm, Stopfendurchmesser 118 mm, 3 seitliche Anschlüsse mit Durchmesser 50 mm, einseitiger Abgang mit Durchmesser 63/50 mm. Die seitlichen Anschlüsse sind mit einer Dichtung und einem Verschlussstopfen versehen.

Inspection gully in PP with vertical outlet, with blank plug in ABS

Inspektionsschachtablauf aus PP mit vertikalem Abgang, mit Blindstopfen aus ABS



VS0702004



VS0702005

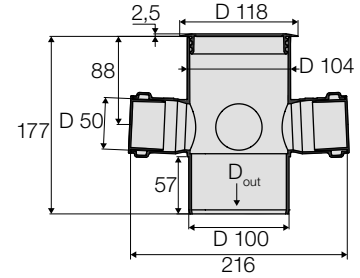
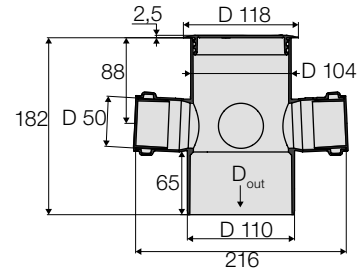

COD.	D _{in}	D _{out}	Cap Colour - Stopfenfarbe				HxLxP	CL	€/pz
VS0702004	4x50	1x110	pergamon	6	24	72	850x800x1200	SF01	29,49
VS0702005	4x50	1x100	pergamon	6	24	72	850x800x1200	SF01	29,49

Inspection gully made of PP, grey in colour, with a top inlet for cleaning, equipped with blank plug with 2 o-rings that guarantee a tight seal, 104 mm diameter body, 118 mm diameter plug, four 50 mm diameter side inlets, 110 or 100 mm diameter vertical outlet. The side inlets are equipped with ring seal and cap.

Inspektionsschachtablauf aus PP mit Siphon, aus PP, Farbe grau, mit einem oberen Einlauf zur Reinigung, ausgestattet mit einem Blindstopfen mit 2 O-Ringen, die seine hermetische Abdichtung gewährleisten, Körperdurchmesser 104 mm, Stopfendurchmesser 118 mm, 4 seitliche Anschlüsse mit Durchmesser 50 mm, einem vertikalen Abgang D 110 oder D 100 mm. Die seitlichen Einläufe sind mit einer Dichtung und einem Verschlussstopfen versehen.

Spare parts - Ersatzteile

Water seal
Sperrwassereinsatz

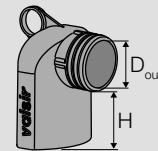

COD.	H		CL	€/pz
VS0701701	50	1	SF01	5,95

For codes - Für ART.-NR. VS0702001-VS0702002.

D 40 single lip rubber ring
Einlippendichtung D 40





COD.	D		CL	€/pz
VS0391003	40	50	CC01	0,45
VS0391005	50	50	CC01	0,45

Spare parts - Ersatzteile

ABS grid cap

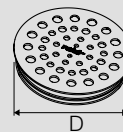
Stopfen mit Rost aus ABS



COD.	D	Colour - Farbe		CL	€/pz
VS0702007	104	white - weiß	5	SF01	6,37
VS0702009	104	pergamon	5	SF01	6,37

Blank plug

Blindstopfen

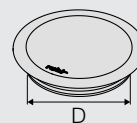



COD.	D	Colour - Farbe		CL	€/pz
VS0702008	104	white - weiß	5	SF01	6,37
VS0702010	104	pergamon	5	SF01	6,37

Accessories - Ersatzteile

Extension for trap

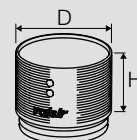
Verlängerung für Siphon



COD.	D	H	Colour - Farbe		CL	€/pz
VS0702006	104	70	white - weiß	20	SF01	7,41

**HDPE floor gully,
trapped and
accessible, with
backflow preventing
valve, fusion weld**

*Boden-Schachtablauf
komplett, aus HDPE, mit
Siphon inspektionierbar,
mit Rückstauverschluss,
Schweißverbindung*

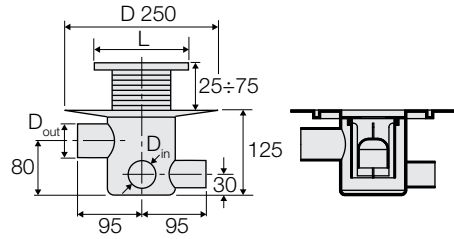

COD.	D _{out}	D _{in}	LxL				HxLxP	CL	€/pz
VS0700320	50	3x40	100x100	1	8	56	970x800x1200	SF01	38,81
VS0700324	50	3x40	140x140	1	8	56	970x800x1200	SF01	41,76

Gully in HDPE made up of three 40 mm inlets and one 50 mm outlet and incorporating a back flow preventing valve (anti-foam); the inlets are all closed and must be drilled in case of use. The gully is provided with an extension (range 25 to 75 mm) and a stainless steel grating, with different dimensions L depending on the model.

Schachtablauf aus Polyethylen, bestehend aus 3 Anschlüssen mit einem Durchmesser von 40 mm und 1 Abgang mit Durchmesser von 50 mm und ausgestattet mit Rückstauverschluss (Antischaum); die Einläufe sind verschlossen und müssen zur Verwendung gebohrt werden. Das Schachtrohr ist mit einer Verlängerung (25÷75 mm Höhe) und einem Edelstahlrost mit unterschiedlichen Abmessungen L je nach Modell ausgestattet.

Spare parts - Ersatzteile

**Stainless steel grating with
support and filter**

*Edelstahlrost mit Stützstück
und Filter*

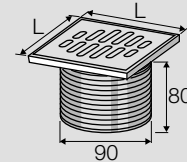

COD.	L		CL	€/pz
VS0703017	100x100	1	SF01	14,58
VS0703119	135x135	1	SF01	15,23

Stainless steel grating

Edelstahlrost

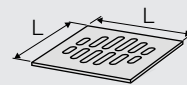

COD.	L		CL	€/pz
VS0703133	100x100	1	SF01	8,80
VS0703135	128x128	1	SF01	8,80

**Backflow preventing valve
(anti-foam)**

*Rückstauverschluss
(Antischaummittel)*



COD.		CL	€/pz
VS0703125	1	SF01	6,58

Spare parts - Ersatzteile

Flange, seal and screws for PVC sheet

Flansch, Dichtung und Schrauben für PVC-Folie

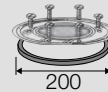





COD.			CL	€/pz
VS0700313	1		SF01	23,15

Accessories - Ersatzteile

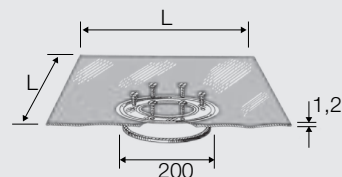
PVC sheet, with flange, seal and screws

PVC-Folie komplett mit Flansch, Dichtung und Schrauben



COD.	LxL				HxLxP 	CL	€/pz
VS0700311	500x500	1	20	140	935x800x1200	SF01	36,97
VS0700312	1200x1200	1	16	80	970x800x1200	SF01	63,80

PP inspectable floor gully

Boden-Schachtablauf komplett, aus PP, inspektionierbar

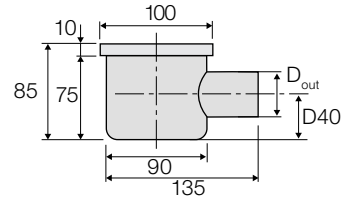

COD.	D _{out}				HxLxP	CL	€/pz
VS0700380	40	15	120	480	1010x800x1200	SF01	11,42

Floor gully in polypropylene (PP) with one 40 mm horizontal outlet. The gully includes a frame and 100x100 mm stainless steel grating. The gully height of 85 mm makes it suitable for those applications with limited space, such as terraces.

Schachtablauf aus Polypropylen (PP) mit 1 horizontalen Abgang mit Durchmesser 40 mm. Der Schachtablauf ist komplett mit Rahmen und Rost aus Edelstahl 100x100 mm. Der Schachtablauf, der sich durch eine Höhe von 85 mm auszeichnet, eignet sich für Anwendungen, die eine geringe Grundfläche erfordern, wie z.B. die Entwässerung von Terrassen.

TRAPS
ABLAUFSIPHONS

Spare parts - Ersatzteile

Stainless steel grating with frame

Edelstahlrost komplett mit Rahmen

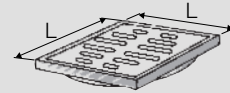

COD.	LxL		CL	€/pz
VS0703137	100x100	1	SF01	12,23

Stainless steel grating

Edelstahlrost

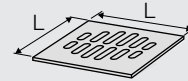

COD.	L		CL	€/pz
VS0703133	94x94	1	SF01	8,80





FLOOR AND TERRACE DRAINS

BODEN-UND TERRASSENABLÄUFE

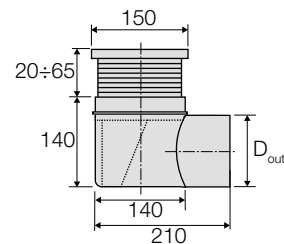
PP floor gully, trapped and inspectable

Boden-Schachtablauf
komplett, aus PP, mit
Siphon inspektionierbar



COD.	D _{out}				HxLxP 	CL	€/pz
VS0700301	75	2	16	80	1030x800x1200	SF01	126,41
VS0700303	110	2	16	80	1030x800x1200	SF01	126,41

Gully in polypropylene (PP) with either a 75 mm or 110 mm horizontal outlet depending on the model. The gully includes a frame and 150x150 stainless steel grating, an extension with an adjustable range of 20 to 65 mm and leaf basket. Thanks to its size it suits drainage applications in cellars, garages, underground areas, etc.

Schachtablauf aus Polypropylen (PP) mit 1 horizontalen Abgang mit Durchmesser 75 mm oder 110 mm, je nach Modell. Der Schachtablauf ist komplett mit Rahmen und Rost aus Edelstahl 150x150 mm, Verlängerung mit verstellbarer Höhe von 20÷65 mm und Korb gegen Blätter. Aufgrund seiner Größe ist er besonders geeignet für Entwässerungsanwendungen in Kellern, Garagen, Kellergeschoss, bzw.

Spare parts - Ersatzteile

Extension with stainless steel grating

Verlängerung komplett mit
Edelstahlrost

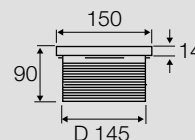

COD.		CL	€/pz
VS0703015	1	SF01	156,70

Complete PP floor gully, for inspection with HDPE connection

Boden- Abflussschacht aus Polypropylen, überprüfbar, mit Verbindung aus HDPE

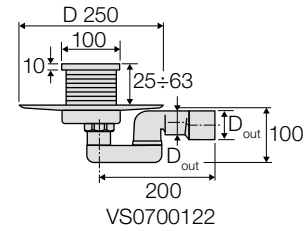
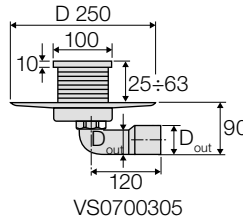
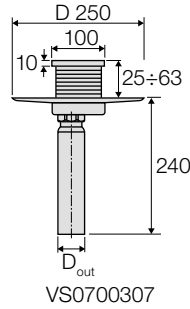

COD.	D _{out}				HxLxP	CL	€/pz
VS0700307	50	1	16	80	970x800x1200	SF01	49,18
VS0700305	50/40	1	16	80	970x800x1200	SF01	29,98
VS0700122	50/40	1	16	80	970x800x1200	SF01	34,04

Gully body made of polypropylene (PP) and outlet of polyethylene (HDPE) diameter 50 mm or 40/50 mm depending on the model; the dual diameter connection is very useful if the connection pipe diameter is not known in advance. The gully includes a frame with 100x100 mm stainless steel grating, extension with adjustable range of 25 to 75 mm and leaf basket. The gully is available in three different versions depending on the connection: vertical, horizontal with dual diameter or swivel trapped connection with dual diameter.

Abflussschacht-Körper aus Polypropylen (PP) und Auslauf aus Polyethylen (HDPE) mit Durchmesser 50 mm oder 40/50 mm je nach Modell; die Verbindung mit doppeltem Durchmesser ist äußerst nützlich, wenn der Durchmesser des Anschlussrohres nicht im Voraus bekannt ist. Der Schachtablauf ist komplett mit Rahmen mit Edelstahlrost 100x100 mm, Verlängerung mit einstellbarer Höhe von 25÷75 mm und Korb gegen Blätter. Der Schachtablauf ist in drei verschiedenen Versionen erhältlich: Vertikalabgang, Horizontalabgang mit doppeltem Durchmesser oder verstellbarer Siphon-Anschluss mit doppeltem Durchmesser.

Spare parts - Ersatzteile

Stainless steel grating with support and filter

Edelstahlrost mit Stützstück und Filter

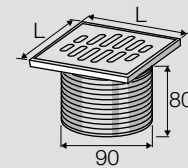

COD.	L		CL	€/pz
VS0703017	100x100	1	SF01	14,58
VS0703119	135x135	1	SF01	15,23

Stainless steel grating

Edelstahlrost

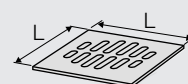

COD.	L		CL	€/pz
VS0703133	100x100	1	SF01	8,80
VS0703135	128x128	1	SF01	8,80

Spare parts - Ersatzteile

Flange, seal and screws for PVC sheet

Flansch, Dichtung und Schrauben für PVC-Folie



COD.		CL	€/pz
VS0700313	1	SF01	23,15

White filter

Filter weiss







COD.		CL	€/pz
VS0703019	1	SF01	4,08

Accessories - Ersatzteile

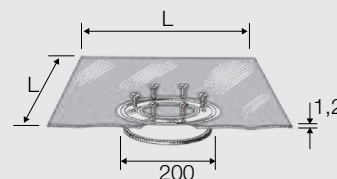
PVC sheet, with flange, seal and screws

PVC-Folie komplett mit Flansch, Dichtung und Schrauben



COD.	LxL				HxLxP 	CL	€/pz
VS0700311	500x500	1	20	140	935x800x1200	SF01	36,97
VS0700312	1200x1200	1	16	80	970x800x1200	SF01	63,80

TRAPS FOR WASHING MACHINE

WASCHMASCHINENABLAUFSIPHON

In-wall trap for washing machine, with stop valve and tail

Unterputz-Waschmaschi-
nensiphon mit Absperr-
ventil und Schlauchan-
schluss

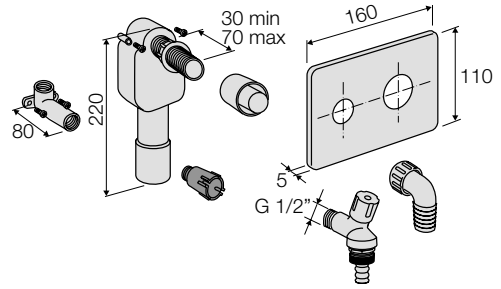



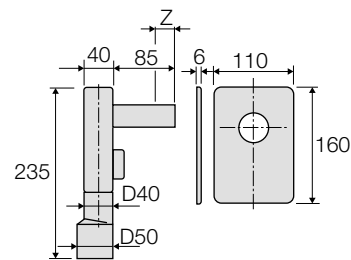

COD.		CL	€/pz
VS0704003	5	SF01	110,31

Recessed trap for washing machine

Unterputzsiphon
komplett für
Waschmaschinen



COD.	D _{out}	Z*	Cover plate - Abdeckhaube				HxLxP 	CL	€/pz
VS0700185	40/50	40	White polypropylene (PP) Polypropylen (PP) weiß	20	80	240	1039x800x1200	SF01	16,04
VS0700035	40/50	40	Stainless steel - Edelstahl	20	80	240	1039x800x1200	SF01	16,15

* Max cut length. - Maximaler Schnitt erlaubt.

Washing machine traps with cover plate, hose holder, ring nut for securing plate and access cap.

Unterputzsiphons für Waschmaschinen komplett mit Abdeckplatte, Schlauchhalterung, Ringmutter zur Plattenbefestigung und Inspektionsstopfen.

Washing machine outlet with mechanical closure

Waschmaschinenabfluss mit mechanischem Verschluss



Mod. A1

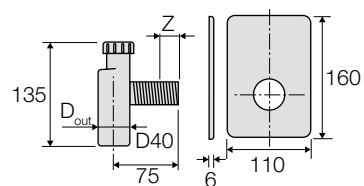

Mod. A2

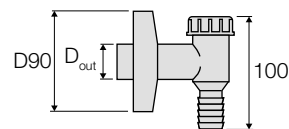

COD.	Mod.	D _{out}	Z*	Cover plate - Abdeckhaube				HxLxP	CL	€/pz
VS0700187	A1	40	40	White polypropylene (PP) <i>Polypropylen (PP) weiß</i>	20	160	800	1030x800x1200	SF01	11,27
VS0700037	A1	40	40	Stainless steel - <i>Edelstahl</i>	20	160	640	1010x800x1200	SF01	11,87
VS0700189	A2	32	-	-	20	160	1120	970x800x1200	SF01	8,56

* Max cut length. - *Maximaler Schnitt erlaubt.*

Mod. A1: Washing machine waste in polyethylene (HDPE) with cover plate, hose holder, nut for securing plate, access cap and sphere for prevention of foul odours return.

Mod. A2: trap for washing machine in white polypropylene (PP) with escutcheon and sphere for prevention of foul odours return.

Mod. A1: Waschmaschinenablauf aus Polyethylen (HDPE) komplett mit Abdeckhaube, Schlauchhalterung, Ringmutter für Plattenbefestigung, Inspektionsstopfen und Kugel mit Rücklaufsperr für Gerüche.

Mod. A2: Waschmaschinenablauf aus weißem Polypropylen (PP) komplett mit Rosette und Kugel mit Rücklaufsperr für Gerüche.

Spare parts - Ersatzteile

Stainless steel cover plate
 Edelstahl-Abdeckhaube



COD.		CL	€/pz
VS0703080	10	SF01	4,83
For codes - Für ART.-NR. VS0700185-VS0700035-VS0700187-VS0700037-VS0700189.			

White PP cover plate
 Abdeckhaube aus weißem PP



COD.		CL	€/pz
VS0703090	10	SF01	2,62
For codes - Für ART.-NR. VS0700185-VS0700035-VS0700187-VS0700037-VS0700189.			

Connector with ring nut
 Schlauchanschluss komplett
 mit Ringmutter



COD.		CL	€/pz
VS0703070	10	SF01	2,95
For codes - Für ART.-NR. VS0700185-VS0700035-VS0700187-VS0700037-VS0700189.			

Inspection plug
 Inspektionsstopfen mit Dichtung



COD.		CL	€/pz
VS0703071	10	SF01	0,59
For codes - Für ART.-NR. VS0700185-VS0700035-VS0700187-VS0700037-VS0700189.			

Plate-tightening ring nut
 Ringmutter für Plattenbefestigung



COD.		CL	€/pz
VS0703073	10	SF01	1,29
For codes - Für ART.-NR. VS0700185-VS0700035-VS0700187-VS0700037-VS0700189.			

TRAPS FOR CONDENSATION DRAINAGE

KONDENSATABLAUFSIPHONS

HDPE trap for condensation drainage

Kondensatablaufsiphons aus HDPE

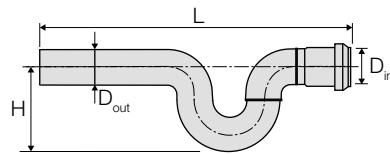

COD.	D _{out}	D _{in}	L	H				HxLxP	CL	€/pz
VS0700271	32	32	260	75	10	80	800	970x800x1200	SF01	15,70
VS0700272	40	40	320	90	10	80	400	1030x800x1200	SF01	23,76

HDPE traps for condensation drainage for fusion weld joint with protection cap. Used for drainage of condensation water from air-conditioning units and condensation boilers.

Kondensatablaufsiphons aus Polyethylen (HDPE) mit Schweißverbindung und Schutzstopfen. Sie werden zur Ableitung von Kondenswasser aus Klimaanlage und Kondensationskesseln eingesetzt.

Welded. - Abzweiger angeschweißt.

TRAPS FOR SPECIAL WASTE APPLICATIONS

SIPHONS FÜR SPEZIELLE ANWENDUNGEN

HDPE traps for special waste applications

Siphon für spezielle Anwendungen aus HDPE



Mod. A1

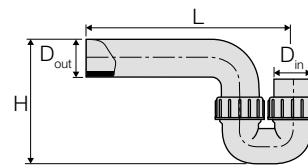

Mod. A2

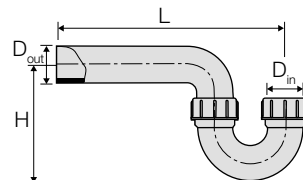

TRAPS
ABLAUFSIPHONS

COD.	Mod.	D _{out}	D _{in}	L	H				HxLxP	CL	€/pz
VS0700833	A1	63	63	310	235	1	-	100	-	SF01	80,05
VS0700835	A1	75	75	345	335	1	-	90	-	SF01	101,74
VS0700839	A1	90	90	385	320	1	-	50	-	SF01	119,99
VS0700840	A1	110	100	430	370	1	-	40	-	SF01	145,64
VS0700814	A2	40	40	230	140	10	80	400	1030x800x1200	SF01	43,51
VS0700815	A2	50	50	280	170	10	80	240	1015x800x1200	SF01	43,51
VS0700813	A2	56	50	310	165	10	40	120	850x800x1200	SF01	57,39

HDPE traps for fusion weld jointing. Various models are available with horizontal or vertical connection. - Industriesiphons aus Polyethylen (HDPE) mit Schweißverbindung. Verschiedene Modelle sind mit horizontalem oder vertikalem Anschluss erhältlich.

Welded. - Abzweiger angeschweißt.

Accessories - Ersatzteile

Washing machine connector for HDPE welding

Waschmaschinenanschluss für HDPE Schweißverbindung

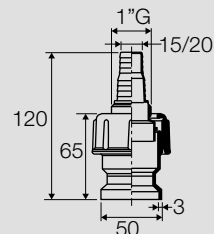

COD.	D _{out}				HxLxP	CL	€/pz
VS0700853	50	20	160	1280	970x800x1200	SF01	15,18

Welded. - Abzweiger angeschweißt.

TRAPS FOR SPECIAL WASTE APPLICATIONS
SIPHONS FÜR SPEZIELLE ANWENDUNGEN

HDPE traps for special waste applications

Siphon für spezielle Anwendungen aus HDPE

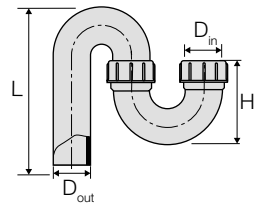

Mod. A1

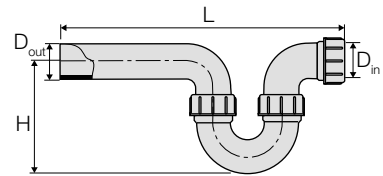

Mod. A2

COD.	Mod.	D _{out}	D _{in}	L	H				HxLxP	CL	€/pz
VS0700809	A1	40	40	160	110	10	80	400	1030x800x1200	SF01	57,39
VS0700801	A1	56	40	238	110	10	80	240	1015x800x1200	SF01	57,39
VS0700805	A1	50	50	180	110	10	80	240	1015x800x1200	SF01	57,39
VS0700803	A1	56	50	190	120	10	40	120	853x800x1200	SF01	57,39
VS0700819	A2	40	40	320	140	10	80	240	1015x800x1200	SF01	71,58
VS0700823	A2	50	50	370	170	10	40	120	970x800x1200	SF01	71,58

HDPE traps for fusion weld jointing. Various models are available with horizontal or vertical connection. - Industriesiphons aus Polyethylen (HDPE) mit Schweißverbindung. Verschiedene Modelle sind mit horizontalem oder vertikalem Anschluss erhältlich.

Welded. - Abzweiger angeschweißt.

Accessories - Ersatzteile

Washing machine connector for HDPE welding

Waschmaschinenanschluss für HDPE Schweißverbindung

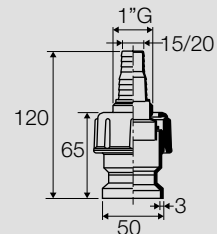

COD.	D _{out}				HxLxP	CL	€/pz
VS0700853	50	20	160	1280	970x800x1200	SF01	15,18

Welded. - Abzweiger angeschweißt.

CONNECTION FITTINGS AND ANCILLARY PARTS

BAUTEILE UND VERBINDUNGSELEMENTE

Air admittance valve

Belüfter

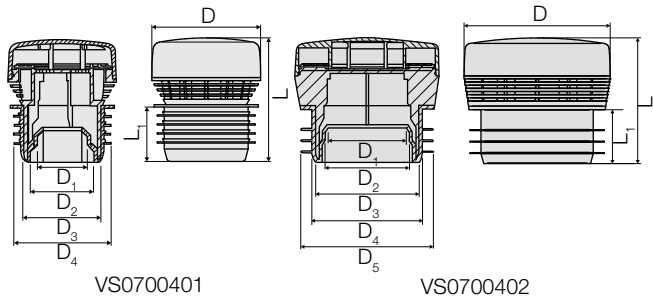

COD.	D	D ₁	D ₂	D ₃	D ₄	D ₅	L	L ₁		CL	€/pz
VS0700401	70	32	40	50	63	-	79,5	35	12	SF01	55,18
VS0700402	125	70	75	90	100	110	108	46	6	SF01	101,67

It allow the venting of pipe sections that are longer than 4 m and avoiding indirect venting systems. Thanks to the compact size it can easily be installed in tight spaces (niches, hanging ceilings or under sinks).

Dies ermöglicht die Belüftung von Rohrleitungsabschnitten größer als 4 m ohne indirekte Belüftungssysteme. Dank seiner geringen Größe kann er problemlos in kleinen Räumen (Abstellräumen, Zwischendecken oder unter Waschbecken) installiert werden.

Eccentric reducer

Reduzierstück
exzentrisch

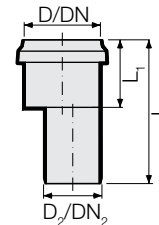

COD.	D/D ₂	DN/DN ₂	L	L ₁				HxLxP	CL	€/pz
VS0700033	50/40	50/40	99	48	30	240	1680	970x800x1200	PP02	4,09
VS0700034	40/32	40/30	95	50	30	480	2400	970x800x1200	PP02	4,26
VS0700039	75/50	70/50	101	50	20	160	1120	970x800x1200	PP02	4,64

Brass sleeve with seal for connection to metal pipes

Anschlussstück an
Metallrohr, aus Messing,
mit Dichtung

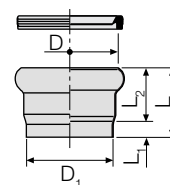

COD.	D	D ₁	L	L ₁	L ₂				HxLxP	CL	€/pz
VS0570001	32	32	61	26	33	40	800	5600	960x800x1200	SF01	6,57
VS0570002	40	32	59	28	25	40	800	5600	935x800x1200	SF01	6,57
VS0570003	40	40	55	25	25	40	800	5600	935x800x1200	SF01	6,57

**Solvent weld adaptor
 for connection to
 PVC**

*Anschlussstück an PVC
 (zum Kleben)*

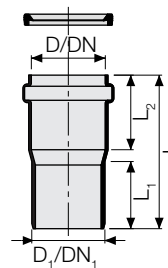

COD.	D/D ₁	DN/DN ₁	L	L ₁	L ₂	kg				HxLxP	CL	€/pz
VS0564121	40/40	40/40	105	50	55	0,045	40	320	1920	970x800x1200	SF01	4,66
VS0564122	50/47	50/40	105	44	47	0,051	30	240	1440	970x800x1200	SF01	5,13
VS0564123	50/50	50/50	105	50	55	0,054	30	240	1440	970x800x1200	SF01	4,79
VS0564150	50/100	50/100	130	91	40	0,186	10	80	480	970x800x1200	SF01	16,45
VS0564075	75/75	70/70	144	87	58	0,177	15	120	480	850x800x1200	SF01	10,02
VS0564131	75/80	70/80	154	78	75	0,176	15	120	480	1010x800x1200	SF01	10,02
VS0564182	75/82	70/80	159	78	80	0,197	15	120	480	850x800x1200	SF01	10,03
VS0564175	75/100	70/100	156	77	77	0,143	10	80	480	970x800x1200	SF01	12,01
VS0564190	90/100	90/100	143	76	65	0,216	10	80	320	1010x800x1200	SF01	11,13
VS0564101	110/100	100/100	147	83	57	0,241	10	80	320	1010x800x1200	SF01	15,50
VS0564251	110/125	100/125	145	83	60	0,290	10	80	240	1015x800x1200	SF01	11,69

Spare parts - Ersatzteile

1-lip seal for sockets

Ersatzlippendichtring



COD.	D		CL	€/pz
VS0391001	32	50	CC01	0,45
VS0391003	40	50	CC01	0,45
VS0391005	50	50	CC01	0,45
VS0391011	75	20	CC01	0,55
VS0391013	90	20	CC01	0,68
VS0391222	100	20	CC01	0,79

**Flexible pipe with
 seal and ring nut**

*Flexschlauch mit Dich-
 tung und Ringmutter*

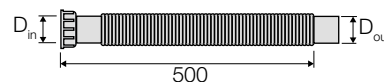

COD.	D _{out}	D _{in}				HxLxP	CL	€/pz
VS0700077 •	32	1"¼	5	40	320	970x800x1200	SF01	11,10
VS0700078 •	40	1"½	5	40	320	970x800x1200	SF01	12,19

Flexible pipe to be used as an accessory for washbasin/sink traps or as a connection element between the bend and drain of the sanitary fixture. - *Flexschlauch zur Verwendung als Zubehör für Waschtisch/Ausgussbecken oder als Verbindungselement zwischen dem Abflussbogen und der Ablaufgarnitur des Sanitäreinrichtung.*

• Sell out. - *Ausverkauf.*

**Reducers
(male-female)**

Reduzierstücke
(innen-aussen)

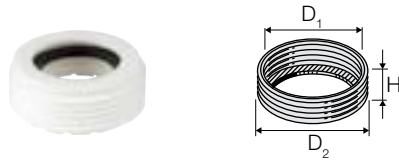

Mod. A

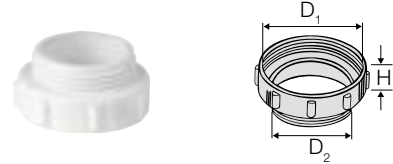

Mod. B

COD.	Mod.	D ₁	d ₂	H		CL	€/pz
VS0700068	A	1"	1"¼	15	20	SF01	1,40
VS0700065	A	1"¼	1"½	15	20	SF01	1,40
VS0700066	B	1"½	1"¼	15	20	SF01	1,40

**In-wall washbasin
trap, cold and
hot water inlets
F1/2"xF1/2",
outlet Ø 50/40**

Unterputzsiphon für Wa-
schbecken, Warm- und
Kaltwasser
IG 1/2"x IG 1/2", Abgang
Ø 50/40

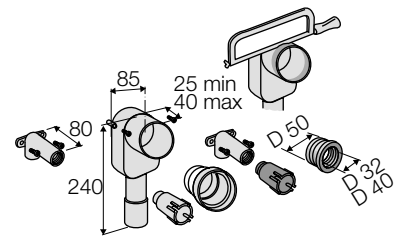

COD.		CL	€/pz
VS0704001	5	SF01	86,84

**In-wall washbasin
trap, outlet Ø 50/40**

Unterputzsiphon für Wa-
schbecken, Abgang
Ø 50/40

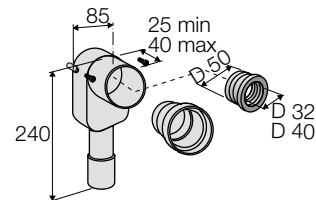

COD.		CL	€/pz
VS0704002	1	SF01	32,92

**ABS elbow for in-
wall trap Ø 32x1"¼
complete with rubber
grommet**

Ablaufbogen für Unter-
putzsiphon Ø 32x1"¼
ABS komplett mit Gum-
mimanschette

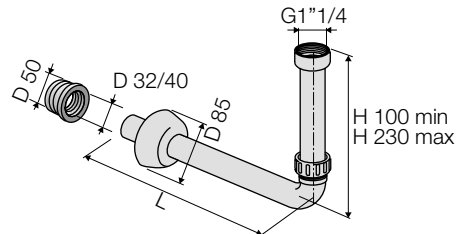

COD.		CL	€/pz
VS0704005	1	SF01	13,02

ABS elbow for in-wall trap Ø 40x1"½ complete with rubber grommet

Ablaufbogen für Unterputzsiphon Ø 40x1"½
 ABS komplett mit Gummimanschette

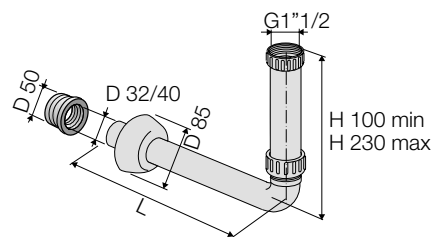

COD.		CL	€/pz
VS0704006	1	SF01	13,02