



Pexal® Brass: brass crimp fittings

Pexal® Brass: mosazné lisované tvarovky

PEXAL[®] BRASS , BRASS CRIMP FITTINGS

PEXAL[®] BRASS, MOSAZNÉ LISOVANÉ TVAROVKY



Pexal[®] Brass crimp fittings are produced with a brass alloy body and stainless steel sleeve fixed with a ring in transparent polymeric material. They are suited to a multitude of applications, from hot and cold drinking water supply systems to heating and industrial plants. The fittings are equipped with a special base ring in transparent polymeric material that disconnects the aluminium in the pipe from the brass in the fitting, increasing the insertion depth on the insert and allowing greater control. Each fitting is individually wrapped to improve handling on the installation site and for greater protection from dust and debris.

Pexal[®] Mosazné lisované tvarovky jsou tvořeny z lisovaných dílů s mosazným tělem a pouzdra z nerezové oceli. Systém může být použit různými způsoby, od potrubí pro horkou a studenou vodu pro přívod pitné vody, UT, vzduch...

Lisované tvarovky jsou opatřeny speciálním spodním kroužkem vyrobeným z průhledného polymerního materiálu, který tvoří bariéru mezi hliníkem trubky a mosaznou armaturou, zvyšuje hloubku zasunutí do objímky trubky a zlepšuje kontrolu a kvalitu lisovaného spoje. Každý díl je jednotlivě balen, což zajišťuje lepší manipulaci na místě a větší ochranu před prachem a nečistotami.



Crimping profile U, H, C – Pressprofil U, H, C



Crimping profile TH – lisovací profil TH



- Two O-ring seals guarantee maximum hydraulic tightness.
- Sleeve pre-fitted on the fitting in stainless steel AISI 304 with inspection holes.
- Diameters from Ø 16 to 26 mm are characterised by the possibility of verifying correct installation of the product, detecting a leakage in the fitting if the same has not been crimped correctly.
- Diameters Ø 16 to 50 mm are available with multipress profiles for jaws H, TH, U, C, VAL.
- Made of a special brass alloy that is corrosion resistant.
- Possibility of using the product both in water supply and heating or cooling installations.
- Special ring in PTFE to prevent galvanic corrosion between the pipe and fitting.
- Wide range of diameters from Ø 14 to 90 mm.
- Leakage detection during system testing in the event of incomplete pressing on diameters from 16 mm to 32 mm (for leaking test pressure between 0.5 and 2 bar).
- O-kroužek pro maximální hydraulické utěsnění.
- Předmontované pouzdro z nerezové oceli AISI 304 s kontrolními otvory.
- Průměry Ø 16 až 26 mm se vyznačují možností kontroly správné instalace výrobku detekováním úniku vody z lisovaného dílu, pokud není správně vtačen.
- Průměry od 16 do 50 mm jsou k dispozici s tvarovacím profilem Multipress pro obrysy H, TH, C, VAL.
- Vyrobeno ze speciální mosazné slitiny odolné vůči korozi.
- Výrobek lze použít v systémech pitné vody a také v systémech vytápění nebo chlazení.
- Speciální kroužek z PTFE, který zabraňuje galvanické korozi mezi trubkou a lisovaným dílem.
- Velký rozsah průměrů od 14 do 90 mm.
- Indikace netěsností během zkoušky systému (netlaková netěsnost) při nedostatečném tlaku (při tlaku mezi 0,5 a 2 bary).

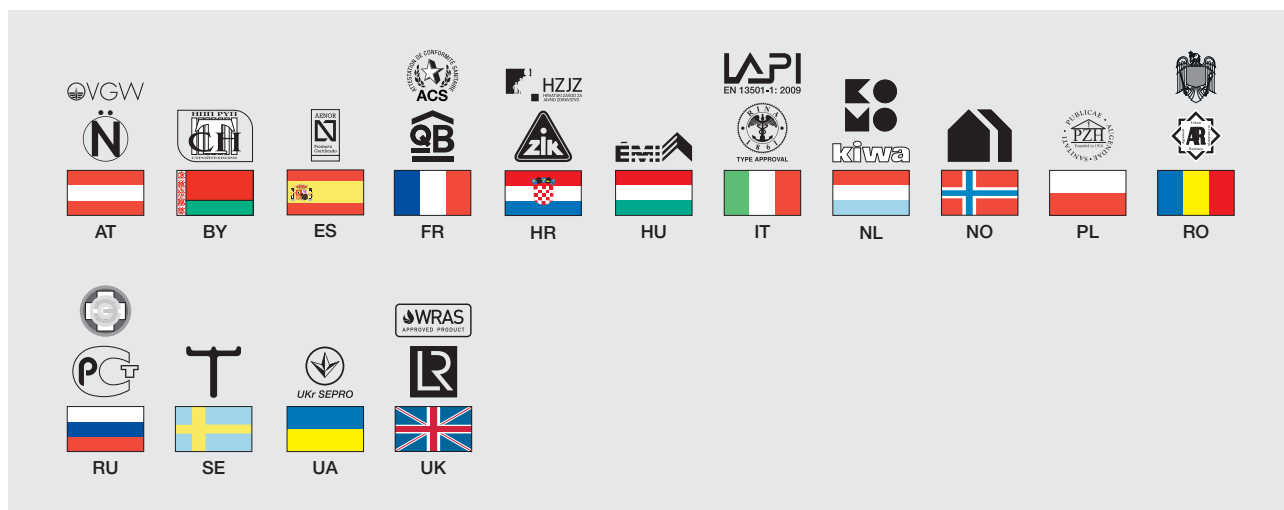

PEXAL BRASS FITTINGS RANGE

SORTIMENT PEXAL MOSAZNÉ LISOVANÉ TVAROVKY

Straight coupling

Spojka – hrdlo

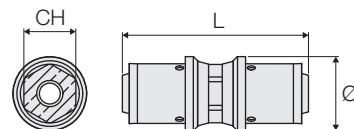

COD.	A	⊗OA	B	⊗OB	L	Ø	CH			CL	Kč/ks
VS0130501	14x2	H	14x2	H	58	20	-	10	250	RXP1	174,00
VS0170003	16x2	H,TH,U	16x2	H,TH,U	68	23	15	10	180	RMP1	148,00
VS0170005	16x2,25	H,TH,U	16x2,25	H,TH,U	68	23	15	10	180	RMP1	148,00
VS0175007	18x2	H,TH,U	18x2	H,TH,U	50	24	-	10	170	RMP1	213,00
VS0170009	20x2	H,TH,U	20x2	H,TH,U	63	27	19	10	140	RMP1	180,00
VS0175010	20x2,25	H,TH,U	20x2,25	H,TH,U	50	26	-	10	140	RMP1	213,00
VS0170011	20x2,5	H,TH,U	20x2,5	H,TH,U	68	27	19	10	140	RMP1	180,00
VS0175012	25x2,5	TH,U	25x2,5	TH,U	50	32	-	10	90	RMP1	304,00
VS0170013	26x3	H,TH,C	26x3	H,TH,C	68	33	25	10	90	RMP1	258,00
VS0170015	32x3	VAL,H,TH,U	32x3	VAL,H,TH,U	78	39	31	5	65	RMP1	403,00
VS0130525	40x3,5	VAL,TH,U	40x3,5	VAL,TH,U	102	47	-	2	30	RXP3	869,00
VS0130529	50x4	VAL,TH,U	50x4	VAL,TH,U	102	57	-	2	30	RXP3	1399,00
VS0130533	63x4,5	VAL,TH,U	63x4,5	VAL,TH,U	150	70	-	2	10	RXP3	2206,00
VS0130535	75x5	VAL,U	75x5	VAL,U	166	83	76	1	5	RXP3	3984,00
VS0130537	90x7	U	90x7	U	168,5	100	95	1	-	RXP3	7792,00

Reducing coupling

Redukční spojka

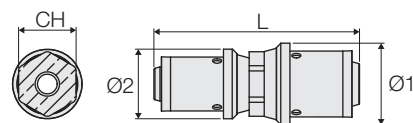

COD.	A	⊗OA	B	⊗OB	L	Ø1	Ø2	CH			CL	Kč/ks
VS0175107	18x2	H,TH,U	16x2	H,TH,U	59	24	22	-	10	150	RMP1	222,00
VS0170119	20x2	H,TH,U	16x2	H,TH,U	65,5	27	23	19	10	150	RMP1	203,00
VS0175111	20x2	H,TH,U	18x2	H,TH,U	59	26	24	-	10	-	RMP1	222,00
VS0175120	20x2,25	H,TH,U	16x2	H,TH,U	59	26	22	-	10	150	RMP1	222,00
VS0170121	20x2,5	H,TH,U	16x2,25	H,TH,U	68	27	23	19	10	150	RMP1	203,00
VS0175132	25x2,5	TH,U	20x2,25	H,TH,U	59	32	26	-	10	110	RMP1	310,00
VS0170127	26x3	H,TH,C	16x2	H,TH,U	68	33	23	25	10	110	RMP1	247,00
VS0170129	26x3	H,TH,C	16x2,25	H,TH,U	68	33	23	25	10	110	RMP1	247,00
VS0175115	26x3	H,TH,C	18x2	H,TH,U	59	32	24	-	10	100	RMP1	310,00
VS0170131	26x3	H,TH,C	20x2	H,TH,U	65,5	33	27	25	10	110	RMP1	263,00
VS0170133	26x3	H,TH,C	20x2,5	H,TH,U	68	33	27	25	10	110	RMP1	263,00
VS0175135	26x3	H,TH,C	25x2,5	TH,U	50	32	32	-	10	90	RMP1	304,00
VS0170143	32x3	VAL,H,TH,U	16x2	H,TH,U	73	39	23	31	5	85	RMP1	358,00
VS0170145	32x3	VAL,H,TH,U	20x2	H,TH,U	70,5	39	27	31	5	85	RMP1	374,00
VS0175146	32x3	VAL,H,TH,U	20x2,25	H,TH,U	64	38	26	-	5	85	RMP1	448,00
VS0170147	32x3	VAL,H,TH,U	20x2,5	H,TH,U	73	39	27	31	5	85	RMP1	374,00
VS0175148	32x3	VAL,H,TH,U	25x2,5	TH,U	64	38	32	-	5	70	RMP1	489,00
VS0170149	32x3	VAL,H,TH,U	26x3	H,TH,C	73	39	33	31	5	70	RMP1	389,00
VS0175158	40x3,5	VAL,TH,U	25x2,5	TH,U	89	40	32	-	2	40	RXP3	1032,00
VS0170159	40x3,5	VAL,TH,U	26x3	H,TH,C	86,5	47	33	-	2	40	RXP3	842,00

PEXAL BRASS FITTINGS RANGE
SORTIMENT PEXAL MOSAZNÉ LISOVANÉ TVAROVKY

COD.	A	OA	B	OB	L	Ø1	Ø2	CH			CL	Kč/ks
VS0170161	40x3,5	VAL,TH,U	32x3	VAL,H,TH,U	91,5	47	39	-	2	38	RXP3	842,00
VS0170171	50x4	VAL,TH,U	32x3	VAL,H,TH,U	91,5	57	39	-	2	28	RXP3	1043,00
VS0130577	50x4	VAL,TH,U	40x3,5	VAL,TH,U	103	57	47	-	2	24	RXP3	1109,00
VS0130579	63x4,5	VAL,TH,U	40x3,5	VAL,TH,U	127	70	47	-	2	14	RXP3	1856,00
VS0130581	63x4,5	VAL,TH,U	50x4	VAL,TH,U	130	70	57	-	2	12	RXP3	1856,00
VS0130583	75x5	VAL,U	50x4	VAL,TH,U	141,5	83	57	76	1	7	RXP3	3415,00
VS0130585	75x5	VAL,U	63x4,5	VAL,TH,U	166	83	70	76	1	6	RXP3	3843,00
VS0130587	90x7	U	63x4,5	VAL,TH,U	166,5	100	70	95	1	-	RXP3	7525,00
VS0130589	90x7	U	75x5	VAL,U	167	100	83	95	1	-	RXP3	7685,00

Female threaded coupling

Přechod s vnitřním závitem F



COD.	A	OA	B (inch)	L	Ø	CH			CL	Kč/ks
VS0130703	14x2	H	1/2"	44	30	27	10	130	RXP1	128,00
VS0170305	16x2	H,TH,U	1/2"	51	29	27	10	150	RMP1	117,00
VS0170309	16x2	H,TH,U	3/4"	52,5	33	31	10	120	RMP1	141,00
VS0170307	16x2,25	H,TH,U	1/2"	51	29	27	10	150	RMP1	117,00
VS0170311	16x2,25	H,TH,U	3/4"	52,5	33	31	10	120	RMP1	141,00
VS0175317	18x2	H,TH,U	1/2"	51	28	26	10	100	RMP1	144,00
VS0175319	18x2	H,TH,U	3/4"	52	34	31	10	100	RMP1	173,00
VS0170321	20x2	H,TH,U	1/2"	48,5	29	27	10	140	RMP1	137,00
VS0170325	20x2	H,TH,U	3/4"	50	33	31	10	110	RMP1	173,00
VS0175322	20x2,25	H,TH,U	1/2"	50	29	26	10	140	RMP1	144,00
VS0175326	20x2,25	H,TH,U	3/4"	52	34	31	10	110	RMP1	173,00
VS0170323	20x2,5	H,TH,U	1/2"	51	29	27	10	140	RMP1	137,00
VS0170327	20x2,5	H,TH,U	3/4"	52,5	33	31	10	110	RMP1	173,00
VS0175334	25x2,5	TH,U	3/4"	52	35	32	10	90	RMP1	228,00
VS0175330	25x2,5	TH,U	1"	65	42	38	10	70	RMP1	276,00
VS0170335	26x3	H,TH,C	3/4"	52,5	34	31	10	90	RMP1	216,00
VS0170331	26x3	H,TH,C	1"	56,5	42	38	10	70	RMP1	276,00
VS0170339	32x3	VAL,H,TH,U	1"	61,5	42	38	5	60	RMP1	366,00
VS0130727	40x3,5	VAL,TH,U	1"1/4	76	55	50	2	30	RXP3	936,00
VS0130729	40x3,5	VAL,TH,U	1"1/2	76	60	55	2	28	RXP3	936,00
VS0130733	50x4	VAL,TH,U	1"1/2	75	60	55	2	26	RXP3	1093,00
VS0130739	63x4,5	VAL,TH,U	2"	105,5	78	70	2	12	RXP3	1789,00
VS0130743	75x5	VAL,U	2"1/2	112,5	92	85	1	8	RXP3	3362,00
VS0130745	90x7	U	3"	118,5	108	98	1	-	RXP3	6430,00

PEXAL BRASS FITTINGS RANGE
SORTIMENT PEXAL MOSAZNÉ LISOVANÉ TVAROVKY

Male threaded coupling

Přechod s vnějším závitem M

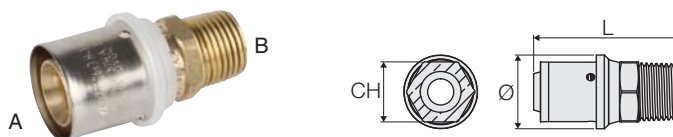

COD.	A	SOA	B (inch)	L	Ø	CH			CL	Kč/ks
VS0130603	14x2	H	1/2"	47	25	22	10	170	RXP1	137,00
VS0170213	16x2	H,TH,U	3/8"	51	23	17	10	230	RMP1	124,00
VS0170205	16x2	H,TH,U	1/2"	54	25	22	10	180	RMP1	108,00
VS0170209	16x2	H,TH,U	3/4"	56	30	27	10	130	RMP1	140,00
VS0170207	16x2,25	H,TH,U	1/2"	54	25	22	10	180	RMP1	108,00
VS0170211	16x2,25	H,TH,U	3/4"	59	30	27	10	130	RMP1	140,00
VS0175217	18x2	H,TH,U	1/2"	52	26	22	10	160	RMP1	129,00
VS0175219	18x2	H,TH,U	3/4"	55	30	27	10	120	RMP1	145,00
VS0170221	20x2	H,TH,U	1/2"	51	27	22	10	160	RMP1	124,00
VS0170225	20x2	H,TH,U	3/4"	53,5	30	27	10	120	RMP1	140,00
VS0175222	20x2,25	H,TH,U	1/2"	52	27	22	10	160	RMP1	129,00
VS0175226	20x2,25	H,TH,U	3/4"	55	30	27	10	120	RMP1	145,00
VS0170223	20x2,5	H,TH,U	1/2"	54	27	22	10	160	RMP1	124,00
VS0170227	20x2,5	H,TH,U	3/4"	56	30	27	10	120	RMP1	140,00
VS0175234	25x2,5	TH,U	3/4"	55	32	27	10	100	RMP1	232,00
VS0175230	25x2,5	TH,U	1"	61	37	34	10	70	RMP1	280,00
VS0170233	26x3	H,TH,C	1/2"	57	33	23	10	120	RMP1	220,00
VS0170235	26x3	H,TH,C	3/4"	56	33	27	10	100	RMP1	209,00
VS0170231	26x3	H,TH,C	1"	59	37	34	10	70	RMP1	280,00
VS0170239	32x3	VAL,H,TH,U	1"	64	39	34	5	65	RMP1	320,00
VS0130627	40x3,5	VAL,TH,U	1"1/4	85	49	45	2	34	RXP3	669,00
VS0130633	50x4	VAL,TH,U	1"1/2	86	57	50	2	26	RXP3	1010,00
VS0130635	50x4	VAL,TH,U	2"	93	76	70	2	14	RXP3	1382,00
VS0130639	63x4,5	VAL,TH,U	2"	118,5	76	70	2	10	RXP3	1815,00
VS0130643	75x5	VAL,U	2"1/2	121,5	92	85	1	7	RXP3	3496,00
VS0130645	90x7	U	3"	124,5	108	98	1	-	RXP3	6537,00

45° elbow

Koleno 45°

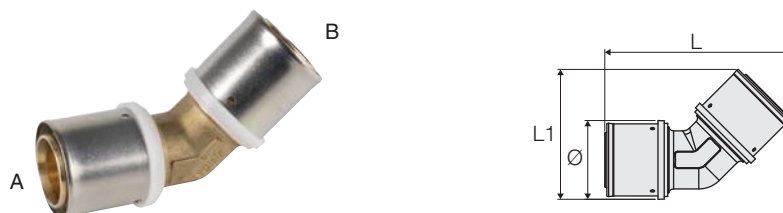

COD.	A	SOA	B	SOB	L	L1	Ø			CL	Kč/ks
VS0130849	40x3,5	VAL,TH,U	40x3,5	VAL,TH,U	122	80,5	47	2	26	RXP3	1308,00
VS0130850	50x4	VAL,TH,U	50x4	VAL,TH,U	130	90	57	2	18	RXP3	1828,00
VS0130851	63x4,5	VAL,TH,U	63x4,5	VAL,TH,U	178	119	70	2	8	RXP3	3070,00
VS0130853	75x5	VAL,U	75x5	VAL,U	194	134,5	83	1	5	RXP3	4994,00
VS0130855	90x7	U	90x7	U	213	151	100	1	-	RXP3	9739,00

90° elbow

Koleno 90°

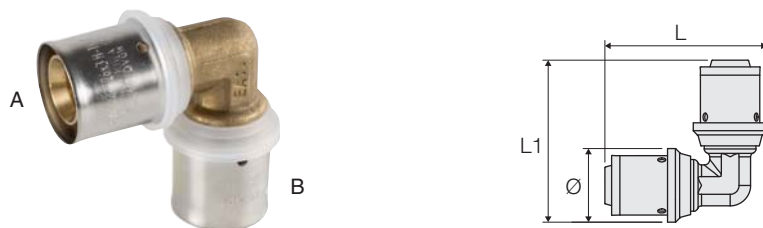

COD.	A	⊙OA	B	⊙OB	L	L1	Ø			CL	Kč/ks
VS0130803	14x2	H	14x2	H	56,5	56,5	20	10	100	RXP1	254,00
VS0170403	16x2	H,TH,U	16x2	H,TH,U	55,5	55,5	23	10	150	RMP1	162,00
VS0170405	16x2,25	H,TH,U	16x2,25	H,TH,U	55,5	55,5	23	10	150	RMP1	162,00
VS0175407	18x2	H,TH,U	18x2	H,TH,U	59	59	24	10	90	RMP1	248,00
VS0170409	20x2	H,TH,U	20x2	H,TH,U	57	57	27	10	100	RMP1	195,00
VS0175410	20x2,25	H,TH,U	20x2,25	H,TH,U	60	60	27	10	100	RMP1	248,00
VS0170411	20x2,5	H,TH,U	20x2,5	H,TH,U	60	60	27	10	100	RMP1	195,00
VS0175412	25x2,5	TH,U	25x2,5	TH,U	66	66	32	10	70	RMP1	402,00
VS0170413	26x3	H,TH,C	26x3	H,TH,C	65,5	65,5	33	10	70	RMP1	306,00
VS0170415	32x3	VAL,H,TH,U	32x3	VAL,H,TH,U	77	77	39	5	45	RMP1	457,00
VS0130827	40x3,5	VAL,TH,U	40x3,5	VAL,TH,U	95,5	95,5	47	2	26	RXP3	1069,00
VS0130833	50x4	VAL,TH,U	50x4	VAL,TH,U	110	110	57	2	16	RXP3	1690,00
VS0130841	63x4,5	VAL,TH,U	63x4,5	VAL,TH,U	146	146	70	2	8	RXP3	3015,00
VS0130843	75x5	VAL,U	75x5	VAL,U	169	169	83	1	4	RXP3	5264,00
VS0130845	90x7	U	90x7	U	186,5	186,5	100	1	-	RXP3	10139,00

Male threaded 90° elbow

Koleno s vnějším
závitem M - 90°

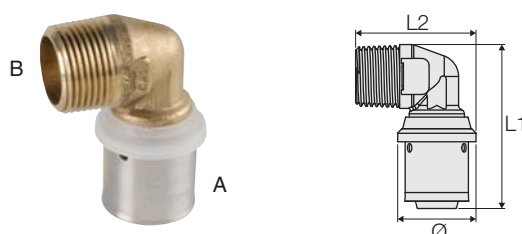

COD.	A	⊙OA	B (inch)	L1	L2	Ø			CL	Kč/ks
VS0131003	14x2	H	1/2"	56	43,5	20	10	100	RXP1	187,00
VS0170505	16x2	H,TH,U	1/2"	56,5	37,5	23	10	150	RMP1	145,00
VS0170507	16x2,25	H,TH,U	1/2"	56,5	37,5	23	10	150	RMP1	145,00
VS0175517	18x2	H,TH,U	1/2"	54	44	24	10	120	RMP1	207,00
VS0170521	20x2	H,TH,U	1/2"	54	41,5	27	10	130	RMP1	175,00
VS0170525	20x2	H,TH,U	3/4"	59,5	42,5	27	10	110	RMP1	230,00
VS0175522	20x2,25	H,TH,U	1/2"	54	45,5	27	10	130	RMP1	207,00
VS0175526	20x2,25	H,TH,U	3/4"	60	48	27	10	110	RMP1	230,00
VS0170523	20x2,5	H,TH,U	1/2"	56,5	41,5	27	10	130	RMP1	175,00
VS0170527	20x2,5	H,TH,U	3/4"	62	42,5	27	10	110	RMP1	230,00
VS0175534	25x2,5	TH,U	3/4"	60	51	32	10	70	RMP1	313,00
VS0175530	25x2,5	TH,U	1"	67	51,5	32	10	70	RMP1	350,00
VS0170535	26x3	H,TH,C	3/4"	62	47,5	33	10	90	RMP1	275,00
VS0170531	26x3	H,TH,C	1"	69	48	33	10	70	RMP1	320,00

PEXAL BRASS FITTINGS RANGE
SORTIMENT PEXAL MOSAZNÉ LISOVANÉ TVAROVKY

COD.	A	SOA	B (inch)	L1	L2	Ø			CL	Kč/ks
VS0170531	26x3	H,TH,C	1"	69,5	50,5	33	10	70	RMP1	320,00
VS0170539	32x3	VAL,H,TH,U	1"	74,5	57,5	39	5	50	RMP1	526,00
VS0131027	40x3,5	VAL,U	1"1/4	94	79,5	47	2	24	RXP3	1203,00
VS0131029 •	40x3,5	VAL,U	1"1/2	109	78	47	2	24	RXP3	1189,00
VS0131033	50x4	VAL,TH,U	1"1/2	105,5	88,5	57	2	18	RXP3	1922,00
VS0131035	50x4	VAL,U	2"	120	93,5	57	2	18	RXP3	2243,00
VS0131039	63x4,5	VAL,TH,U	2"	140	106	70	2	8	RXP3	3468,00

• Sell out – Výprodej

Female threaded 90° elbow

Koleno s vnitřním závitem F- 90°

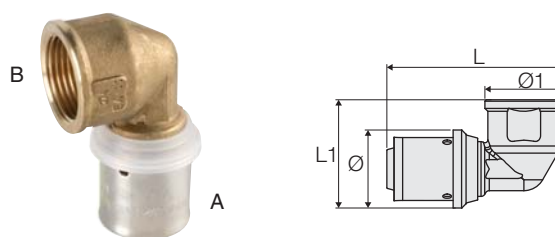

COD.	A	SOA	B (inch)	L	L1	Ø	Ø1			CL	Kč/ks
VS0130903	14x2	H	1/2"	53,5	34	20	27	10	130	RXP1	184,00
VS0170605	16x2	H,TH,U	1/2"	61	33,5	23	27	10	130	RMP1	145,00
VS0170607	16x2,25	H,TH,U	1/2"	61	33,5	23	27	10	130	RMP1	145,00
VS0175617	18x2	H,TH,U	1/2"	60,5	43	24	26	10	100	RMP1	200,00
VS0170621	20x2	H,TH,U	1/2"	58,5	37,5	27	27	10	120	RMP1	171,00
VS0170625	20x2	H,TH,U	3/4"	66	37,5	27	34	10	100	RMP1	223,00
VS0175622	20x2,25	H,TH,U	1/2"	60,5	44,5	27	26	10	120	RMP1	200,00
VS0175626	20x2,25	H,TH,U	3/4"	66,75	44,5	27	32,5	10	100	RMP1	244,00
VS0170623	20x2,5	H,TH,U	1/2"	61	37,5	27	27	10	120	RMP1	171,00
VS0170627	20x2,5	H,TH,U	3/4"	68,5	37,5	27	34	10	100	RMP1	223,00
VS0170634	25x2,5	TH,U	3/4"	66	49	32	32,5	10	-	RMP1	308,00
VS0175630	25x2,5	TH,U	1"	74,5	49	32	40	10	90	RMP1	349,00
VS0170635	26x3	H,TH,C	3/4"	68,5	43,5	33	34	10	80	RMP1	275,00
VS0170631	26x3	H,TH,C	1"	75	48,5	33	40	10	-	RMP1	349,00
VS0170639	32x3	VAL,H,TH,U	1"	80	48,5	39	40	5	50	RMP1	548,00
VS0130927	40x3,5	VAL,TH,U	1"1/4	99	79,5	47	50	2	22	RXP3	1225,00
VS0130933	50x4	VAL,TH,U	1"1/2	109	93	57	56	2	14	RXP3	1559,00
VS0130939	63x4,5	VAL,TH,U	2"	145	108	70	68	2	8	RXP3	3656,00
VS0130941 •	63x4,5	VAL	2"1/2	149	113,5	70	86	2	10	RXP3	3686,00

• Sell out – Výprodej

Union tee

T-kus

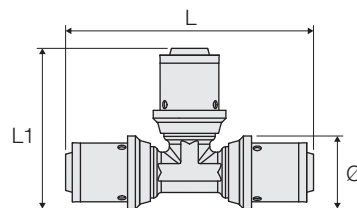

COD.	A	⊗OA	B	⊗OB	C	⊗OC	L	L1	Ø			CL	Kč/ks
VS0131103	14x2	H	14x2	H	14x2	H	89	54,5	20	10	70	RXP1	332,00
VS0170703	16x2	H,TH,U	16x2	H,TH,U	16x2	H,TH,U	88	55,5	23	10	110	RMP1	223,00
VS0170705	16x2,25	H,TH,U	16x2,25	H,TH,U	16x2,25	H,TH,U	88	55,5	23	10	110	RMP1	223,00
VS0175707	18x2	H,TH,U	18x2	H,TH,U	18x2	H,TH,U	94	59	24	10	60	RMP1	332,00
VS0170709	20x2	H,TH,U	20x2	H,TH,U	20x2	H,TH,U	87	57	27	10	80	RMP1	270,00
VS0175710	20x2,25	H,TH,U	20x2,25	H,TH,U	20x2,25	H,TH,U	94	60	27	10	80	RMP1	332,00
VS0170711	20x2,5	H,TH,U	20x2,5	H,TH,U	20x2,5	H,TH,U	92	59,5	27	10	80	RMP1	270,00
VS0175712	25x2,5	TH,U	25x2,5	TH,U	25x2,5	TH,U	100	66	32	10	50	RMP1	523,00
VS0170713	26x3	H,TH,C	26x3	H,TH,C	26x3	H,TH,C	98	65,5	33	10	50	RMP1	429,00
VS0170715	32x3	VAL,H,TH,U	32x3	VAL,H,TH,U	32x3	VAL,H,TH,U	115	77	39	5	30	RMP1	663,00
VS0131125	40x3,5	VAL,TH,U	40x3,5	VAL,TH,U	40x3,5	VAL,TH,U	144	95,5	47	2	18	RXP3	1415,00
VS0131135	50x4	VAL,TH,U	50x4	VAL,TH,U	50x4	VAL,TH,U	162	109,5	57	2	10	RXP3	2232,00
VS0131141	63x4,5	VAL,TH,U	63x4,5	VAL,TH,U	63x4,5	VAL,TH,U	222	146	70	2	4	RXP3	4162,00
VS0131143	75x5	VAL,U	75x5	VAL,U	75x5	VAL,U	255	208	83	1	3	RXP3	7240,00
VS0131145	90x7	U	90x7	U	90x7	U	273	186,5	100	1	-	RXP3	12940,00

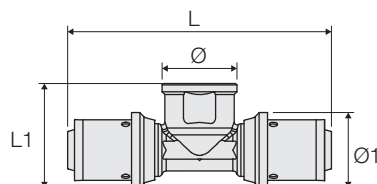

Female threaded union tee

T-kus s vnitřním závitem F



COD.	A	⊗OA	B (inch)	C	⊗OC	L	L1	Ø	Ø1			CL	Kč/ks
VS0131303	14x2	H	1/2"	14x2	H	93	43,5	27	20	10	60	RXP1	283,00
VS0170905	16x2	H,TH,U	1/2"	16x2	H,TH,U	95	33,5	27	23	10	100	RMP1	258,00
VS0170907	16x2,25	H,TH,U	1/2"	16x2,25	H,TH,U	95	33,5	27	23	10	100	RMP1	258,00
VS0175917	18x2	H,TH,U	1/2"	18x2	H,TH,U	95	43	26	24	10	60	RMP1	294,00
VS0170921	20x2	H,TH,U	1/2"	20x2	H,TH,U	90	37,5	27	27	10	80	RMP1	294,00
VS0170925	20x2	H,TH,U	3/4"	20x2	H,TH,U	98	37,5	33,5	27	10	60	RMP1	348,00
VS0175922	20x2,25	H,TH,U	1/2"	20x2,25	H,TH,U	95	44	26	26	10	80	RMP1	294,00
VS0175926	20x2,25	H,TH,U	3/4"	20x2,25	H,TH,U	100	44	32,5	26	10	60	RMP1	348,00
VS0170923	20x2,5	H,TH,U	1/2"	20x2,5	H,TH,U	95	37,5	27	27	10	80	RMP1	294,00
VS0175927	20x2,5	H,TH,U	3/4"	20x2,5	H,TH,U	103	37,5	33,5	27	10	60	RMP1	348,00
VS0175934	25x2,5	TH,U	3/4"	25x2,5	TH,U	100	49	32,5	32	10	50	RMP1	564,00
VS0170935	26x3	H,TH,C	3/4"	26x3	H,TH,C	103	38,5	33,5	33	10	50	RMP1	548,00
VS0170937	32x3	VAL,H,TH,U	3/4"	32x3	VAL,H,TH,U	120	50	33,5	39	5	30	RMP1	780,00
VS0170939	32x3	VAL,H,TH,U	1"	32x3	VAL,H,TH,U	120	51,5	40	39	5	40	RMP1	780,00
VS0131327	40x3,5	VAL,TH,U	1"1/4	40x3,5	VAL,TH,U	148	79,5	50	47	2	16	RXP3	1562,00



PEXAL BRASS FITTINGS RANGE
SORTIMENT PEXAL MOSAZNÉ LISOVANÉ TVAROVKY

COD.	A	⊙OA	B (inch)	C	⊙OC	L	L1	Ø	Ø1			CL	Kč/ks
VS0131331	50x4	VAL,TH,U	1"1/4	50x4	VAL,TH,U	162	89	50	57	2	12	RXP3	2348,00
VS0131333	50x4	VAL,TH,U	1"1/2	50x4	VAL,TH,U	162	89	56	57	2	10	RXP3	2588,00
VS0131339	63x4,5	VAL,TH,U	2"	63x4,5	VAL,TH,U	222	104	68	70	2	6	RXP3	4979,00
VS0131343	75x5	VAL,U	1"	75x5	VAL,U	255	115,5	48	83	1	4	RXP3	5791,00
VS0131345	75x5	VAL,U	1"1/4	75x5	VAL,U	255	118	48	83	1	4	RXP3	5818,00
VS0131347	90x7	U	1"	90x7	U	273	125	54	100	1	-	RXP3	11526,00
VS0131349	90x7	U	1"1/4	90x7	U	273	127,5	54	100	1	-	RXP3	11740,00



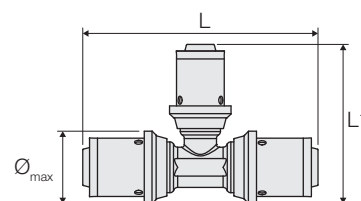

Reducing union tee

T-kus redukční



COD.	A	⊙OA	B	⊙OB	C	⊙OC	L	L1	Ø _{max}			CL	Kč/ks
VS0170807	16x2	H,TH,U	20x2	H,TH,U	16x2	H,TH,U	92	57	27	10	80	RMP1	287,00
VS0175808	16x2	H,TH,U	20x2,25	H,TH,U	16x2	H,TH,U	94	56,5	27	10	80	RMP1	295,00
VS0131701	16x2,25	H	14x2	H	16x2,25	H	91	58	23	10	60	RXP1	337,00
VS0131703	16x2,25	H	16x2,25	H	14x2	H	92	58	23	10	60	RXP1	337,00
VS0175811	18x2	H,TH,U	16x2	H,TH,U	18x2	H,TH,U	94	59	24	10	60	RMP1	319,00
VS0170815	20x2	H,TH,U	16x2	H,TH,U	16x2	H,TH,U	87,5	59,5	27	10	90	RMP1	287,00
VS0170819	20x2	H,TH,U	16x2	H,TH,U	20x2	H,TH,U	83	59,5	27	10	90	RMP1	306,00
VS0170825	20x2	H,TH,U	20x2	H,TH,U	16x2	H,TH,U	89,5	57	27	10	80	RMP1	306,00
VS0175823	20x2	H,TH,U	18x2	H,TH,U	20x2	H,TH,U	94	60	27	10	50	RMP1	332,00
VS0170829	20x2	H,TH,U	26x3	H,TH,C	20x2	H,TH,U	93	62,5	33	10	50	RMP1	457,00
VS0175816	20x2,25	H,TH,U	16x2	H,TH,U	16x2	H,TH,U	91	60	27	10	90	RMP1	295,00
VS0175820	20x2,25	H,TH,U	16x2	H,TH,U	20x2,25	H,TH,U	94	60	27	10	90	RMP1	319,00
VS0175826	20x2,25	H,TH,U	20x2,25	H,TH,U	16x2	H,TH,U	94	60	27	10	80	RMP1	319,00
VS0170817	20x2,5	H,TH,U	16x2,25	H,TH,U	16x2,25	H,TH,U	90	59,5	27	10	90	RMP1	287,00
VS0170821	20x2,5	H,TH,U	16x2,25	H,TH,U	20x2,5	H,TH,U	88	59,5	27	10	90	RMP1	306,00
VS0170827	20x2,5	H,TH,U	20x2,5	H,TH,U	16x2,25	H,TH,U	92	59,5	27	10	80	RMP1	306,00
VS0170831	20x2,5	H,TH,U	26x3	H,TH,C	20x2,5	H,TH,U	98	62,5	33	10	50	RMP1	457,00
VS0175832	25x2,5	TH,U	16x2	H,TH,U	25x2,5	TH,U	91	66	32	10	60	RMP1	525,00
VS0175840	25x2,5	TH,U	20x2,25	H,TH,U	20x2,25	H,TH,U	94	66	32	10	50	RMP1	531,00
VS0175844	25x2,5	TH,U	20x2,25	H,TH,U	25x2,5	TH,U	94	66	32	10	60	RMP1	549,00
VS0170881	26x3	H,TH,C	16x2	H,TH,U	16x2	H,TH,U	98	65,5	33	10	60	RMP1	457,00
VS0170833	26x3	H,TH,C	16x2	H,TH,U	26x3	H,TH,C	92	65,5	33	10	60	RMP1	498,00
VS0170835	26x3	H,TH,C	16x2,25	H,TH,U	26x3	H,TH,C	92	65,5	33	10	60	RMP1	498,00
VS0175837	26x3	H,TH,C	18x2	H,TH,U	26x3	H,TH,C	94	66	33	10	40	RMP1	549,00
VS0170839	26x3	H,TH,C	20x2	H,TH,U	20x2	H,TH,U	95,5	63	33	10	60	RMP1	512,00
VS0170843	26x3	H,TH,C	20x2	H,TH,U	26x3	H,TH,C	92	63	33	10	60	RMP1	526,00
VS0170841	26x3	H,TH,C	20x2,5	H,TH,U	20x2,5	H,TH,U	98	65,5	33	10	60	RMP1	512,00
VS0170845	26x3	H,TH,C	20x2,5	H,TH,U	26x3	H,TH,C	92	65,5	33	10	60	RMP1	526,00

PEXAL BRASS FITTINGS RANGE
SORTIMENT PEXAL MOSAZNÉ LISOVANÉ TVAROVKY

COD.	A	 OA	B	 OB	C	 OC	L	L1	Ø _{max}			CL	Kč/ks
VS0170883	26x3	H,TH,C	26x3	H,TH,C	16x2	H,TH,U	98	65,5	33	10	60	RMP1	498,00
VS0170847	26x3	H,TH,C	26x3	H,TH,C	20x2	H,TH,U	95,5	65,5	33	10	60	RMP1	526,00
VS0170849	26x3	H,TH,C	26x3	H,TH,C	20x2,5	H,TH,U	98	65,5	33	10	60	RMP1	526,00
VS0170885	32x3	VAL,H,TH,U	16x2	H,TH,U	16x2	H,TH,U	106,5	71,5	39	5	45	RMP1	595,00
VS0170851	32x3	VAL,H,TH,U	16x2	H,TH,U	32x3	VAL,H,TH,U	103	71,5	39	5	45	RMP1	609,00
VS0170887	32x3	VAL,H,TH,U	20x2	H,TH,U	20x2	H,TH,U	104	66	39	5	40	RMP1	608,00
VS0170853	32x3	VAL,H,TH,U	20x2	H,TH,U	32x3	VAL,H,TH,U	103	66	39	5	40	RMP1	623,00
VS0175854	32x3	VAL,H,TH,U	20x2,25	H,TH,U	32x3	VAL,H,TH,U	120	72	39	5	40	RMP1	758,00
VS0170855	32x3	VAL,H,TH,U	20x2,5	H,TH,U	32x3	VAL,H,TH,U	103	66	39	5	40	RMP1	621,00
VS0175856	32x3	VAL,H,TH,U	25x2,5	TH,U	25x2,5	TH,U	115	72	39	5	40	RMP1	758,00
VS0175858	32x3	VAL,H,TH,U	25x2,5	TH,U	32x3	VAL,H,TH,U	120	72	39	5	40	RMP1	793,00
VS0170857	32x3	VAL,H,TH,U	26x3	H,TH,C	26x3	H,TH,C	106,5	71,5	39	5	40	RMP1	637,00
VS0170859	32x3	VAL,H,TH,U	26x3	H,TH,C	32x3	VAL,H,TH,U	109	71,5	39	5	40	RMP1	650,00
VS0170889	32x3	VAL,H,TH,U	32x3	VAL,H,TH,U	16x2	H,TH,U	110	74	39	5	35	RMP1	609,00
VS0170891	32x3	VAL,H,TH,U	32x3	VAL,H,TH,U	20x2	H,TH,U	107	74	39	5	35	RMP1	623,00
VS0170893	32x3	VAL,H,TH,U	32x3	VAL,H,TH,U	26x3	H,TH,C	109,5	74	39	5	30	RMP1	650,00
VS0170861	40x3,5	VAL,TH,U	20x2	H,TH,U	40x3,5	VAL,TH,U	130	77,5	47	2	24	RXP3	1412,00
VS0175860	40x3,5	VAL,TH,U	20x2,25	H,TH,U	40x3,5	VAL,TH,U	134	80,5	47	2	24	RXP3	1586,00
VS0170862	40x3,5	VAL,TH,U	20x2,5	H,TH,U	40x3,5	VAL,TH,U	130	80	47	2	24	RXP3	1412,00
VS0175873	40x3,5	VAL,TH,U	25x2,5	TH,U	40x3,5	VAL,TH,U	134	80,5	47	2	24	RXP3	1586,00
VS0170863	40x3,5	VAL,TH,U	26x3	H,TH,C	40x3,5	VAL,TH,U	130	80	47	2	24	RXP3	1412,00
VS0170864	40x3,5	VAL,TH,U	32x3	VAL,H,TH,U	32x3	VAL,H,TH,U	125	84,5	47	2	24	RXP3	1412,00
VS0170865	40x3,5	VAL,TH,U	32x3	VAL,H,TH,U	40x3,5	VAL,TH,U	136	85,5	47	2	22	RXP3	1412,00
VS0170866	40x3,5	VAL,TH,U	40x3,5	VAL,TH,U	32x3	VAL,H,TH,U	134,5	95,5	47	2	20	RXP3	1412,00
VS0175868	50x4	VAL,TH,U	25x2,5	H,TH,U	50x4	VAL,TH,U	142	89,5	57	2	14	RXP3	1901,00
VS0170867	50x4	VAL,TH,U	26x3	H,TH,C	50x4	VAL,TH,U	142	89,5	57	2	14	RXP3	1901,00
VS0170869	50x4	VAL,TH,U	32x3	VAL,H,TH,U	50x4	VAL,TH,U	142	94,5	57	2	14	RXP3	1901,00
VS0131755	50x4	VAL,H,TH,U	40x3,5	VAL,TH,U	50x4	VAL,TH,U	150	104,5	57	2	12	RXP3	1901,00
VS0170871	63x4,5	VAL,H,TH,U	32x3	VAL,H,TH,U	63x4,5	VAL,TH,U	208	108	70	2	6	RXP3	3723,00
VS0131759	63x4,5	VAL,TH,U	40x3,5	VAL,TH,U	63x4,5	VAL,TH,U	208	118	70	2	6	RXP3	3723,00
VS0131761	63x4,5	VAL,TH,U	50x4	VAL,TH,U	63x4,5	VAL,TH,U	208	121	70	2	6	RXP3	3723,00
VS0131763	75x5	VAL,U	40x3,5	VAL,TH,U	75x5	VAL,U	255	142,5	83	1	4	RXP3	5938,00
VS0131765	75x5	VAL,U	50x4	VAL,TH,U	75x5	VAL,U	255	139,5	83	1	4	RXP3	6043,00
VS0131767	75x5	VAL,U	63x4,5	VAL,TH,U	63x4,5	VAL,TH,U	250,5	164,5	83	1	4	RXP3	5661,00
VS0131769	75x5	VAL,U	63x4,5	VAL,TH,U	75x5	VAL,U	255	164,5	83	1	3	RXP3	6443,00
VS0131771	90x7	U	63x4,5	VAL,TH,U	90x7	U	273	175	100	1	-	RXP3	12273,00
VS0131773	90x7	U	75x5	VAL,U	90x7	U	273	178,5	100	1	-	RXP3	12673,00

PEXAL BRASS FITTINGS RANGE
SORTIMENT PEXAL MOSAZNÉ LISOVANÉ TVAROVKY

Swivel adaptor with flat end

Přechod s převlečnou maticí (včetně těsnění)

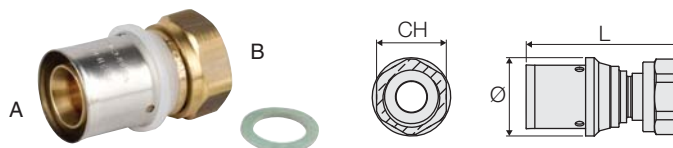

COD.	A	OA	B (inch)	L	Ø	CH			CL	Kč/ks
VS0171113	16x2	H,TH,U	3/8"	45,5	23	21	10	200	RMP1	233,00
VS0171107	16x2	H,TH,U	1/2"	43,5	23	24	10	190	RMP1	221,00
VS0171111	16x2	H,TH,U	3/4"	43,5	23	30	10	140	RMP1	239,00
VS0176109	16x2,25	H,TH,U	1/2"	41	23	24	10	190	RMP1	221,00
VS0171117	20x2	H,TH,U	1/2"	46	27	24	10	140	RMP1	310,00
VS0171119	20x2	H,TH,U	3/4"	41	27	30	10	130	RMP1	333,00
VS0176118	20x2,25	H,TH,U	1/2"	41	27	24	10	140	RMP1	460,00
VS0176120	20x2,25	H,TH,U	3/4"	47	27	30	10	130	RMP1	605,00
VS0176122	25x2,5	TH,U	3/4"	42	32	30	10	90	RMP1	460,00
VS0176124	25x2,5	TH,U	1"	50	32	38	10	70	RMP1	605,00
VS0171123	26x3	H,TH,C	3/4"	49,5	33	30	10	90	RMP1	460,00
VS0171125	26x3	H,TH,C	1"	46,5	33	38	10	70	RMP1	605,00
VS0171131	32x3	VAL,H,TH,U	1"	57,5	39	38	5	50	RMP1	747,00
VS0131627	40x3,5	VAL,H,TH,U	1" 1/4	72,5	47	48	2	24	RXP3	1160,00
VS0131631	50x4	VAL,H,TH,U	1" 1/2	72,5	57	55	2	20	RXP3	1505,00
VS0131633	63x4,5	VAL,H,TH,U	2"	108	70	70	2	10	RXP3	2676,00
VS0131635	75x5	VAL,U	2" 1/2	119,5	83	80	1	7	RXP3	4045,00

Fitting with flat seal. – Přechod je včetně plochého těsnění.

U fitting

U tvarovka s průchozí nástěnkou

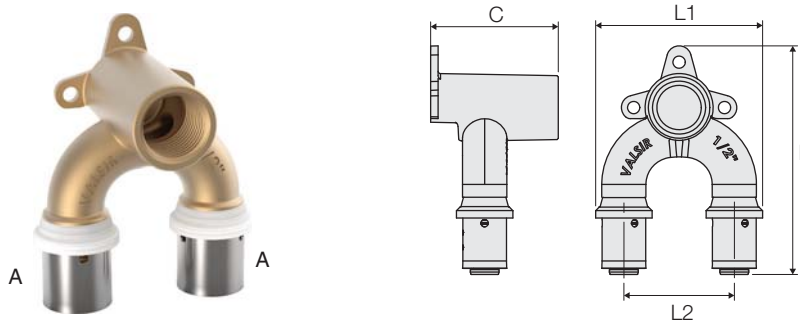

COD.	A	OA	B (inch)	L	L1	L2	C			CL	Kč/ks
VS0171092	16x2	H,TH,U	1/2"	93	68	45	52	5	50	RMP1	1106,00
VS0171094	20x2	H,TH,U	1/2"	88	68	45	52	5	40	RMP1	1215,00

Can be used with fixing plate with codes – Vhodné s montážními deskami ART. - NR. VS0 106001-VS0106002.

Wingback elbow

Nástěnka dlouhá

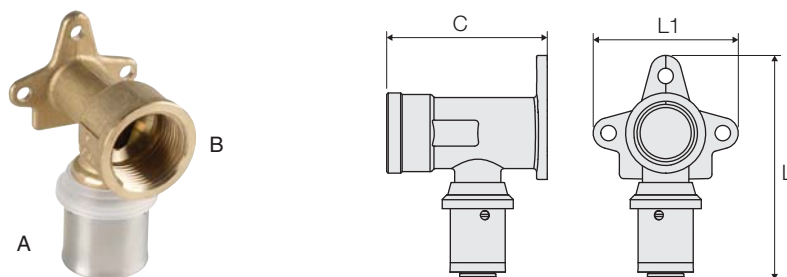

COD.	A		B (inch)	L	L1	C			CL	Kč/ks
VS0131503	14x2	H	1/2"	75	45	50	10	50	RXP1	245,00
VS0171005	16x2	H,TH,U	1/2"	73	47	52	10	80	RMP1	211,00
VS0171007	16x2,25	H,TH,U	1/2"	71	47	52	10	80	RMP1	211,00
VS0176017	18x2	H,TH,U	1/2"	71	45	53	10	70	RMP1	227,00
VS0171021	20x2	H,TH,U	1/2"	64	47	52	10	80	RMP1	227,00
VS0171025	20x2	H,TH,U	3/4"	74	47	53	10	60	RMP1	256,00
VS0176022	20x2,25	H,TH,U	1/2"	71	45	53	10	80	RMP1	227,00
VS0171027	20x2,5	H,TH,U	1/2"	72,5	47	52	10	80	RMP1	227,00
VS0176034	25x2,5	TH,U	3/4"	74	45	53	10	60	RMP1	393,00
VS0171035	26x3	H,TH,C	3/4"	76,5	47	53	10	60	RMP1	393,00

Can be used with fixing plate with codes – [Vhodné s artiklem č. ART. - NR. VS0106001-VS 0106002-VS0106018-VS0106028.](#)

Short wingback elbow

Nástěnka krátká

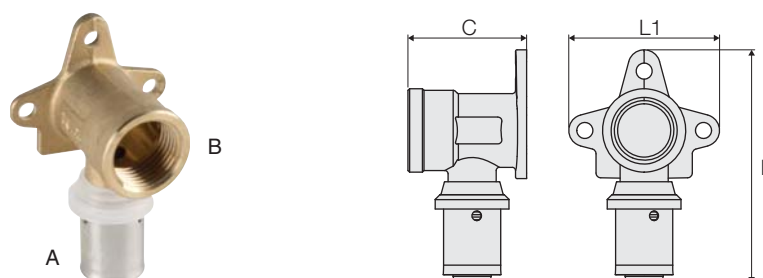

COD.	A		B (inch)	L	L1	C		CL	Kč/ks
VS0171051	16x2	H,TH,U	1/2"	72,5	47	37	10	RMP1	211,00

Can be used with fixing plate with codes – [Vhodné s artiklem ART. - NR. VS0106001-VS01 06002-VS0106018-VS0106028.](#)

Plug for protection and for system testing

Plastové zátky

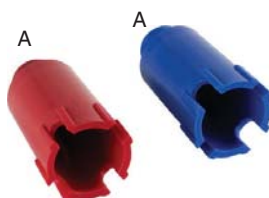

COD.	A (inch)	Colour - Barva		CL	Kč/ks
VS0825051	G1/2" M	blue – modrá	10	ACCA	43,00
VS0825053	G1/2" M	red – červená	10	ACCA	43,00
VS0825056	G3/4" M	blue – modrá	10	ACCA	46,00
VS0825058	G3/4" M	red – červená	10	ACCA	46,00

Plugs with seals. – [Zátka je kompletní s plochým těsněním.](#)

PEXAL BRASS FITTINGS RANGE
SORTIMENT PEXAL MOSAZNÉ LISOVANÉ TVAROVKY

Kit for connection to water outlets

Nástěnkový komplet s montážním setem

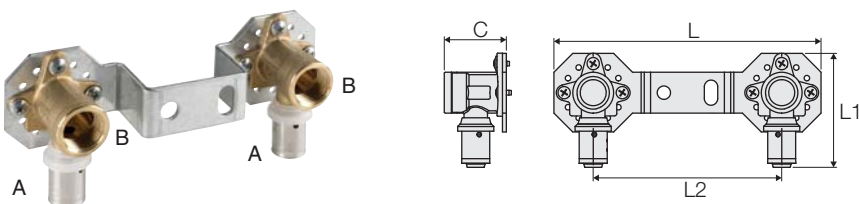

COD.	A	⊕OA	B (inch)	L	L1	L2	C		CL	Kč/ks
VS0171081	16x2	H,TH,U	1/2"	170	72,5	120	39,5	1	RMP1	882,00
VS0171083	16x2	H,TH,U	1/2"	203	72,5	153	39,5	1	RMP1	911,00

The kit is composed of galvanized steel plate, two wingback elbows and fixing screws for fittings. – Sada je složena z pozinkované ocelové desky, dvou nástěnek a upínacích šroubů.

Fixing plates for wall fastening of wingback elbow

Montážní deska - pro nástěnky

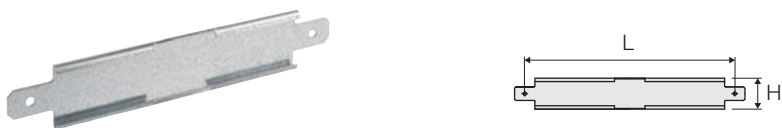

COD.	L	H		CL	Kč/ks
VS0106018	210	45	10	RX00	93,00
VS0106028	310	45	10	RX00	105,00

Fixing plates for wingback elbows

Montážní deska pro nástěnky - tvarovaná



COD.	L	H		CL	Kč/ks
VS0106001	120	50	1	RX00	422,00
VS0106002	153	50	1	RX00	456,00

The plate is supplied with fixing screws for wingback elbows. – Deska také obsahuje upínací šrouby pro montáž nástěnek.

Inspection box for Pexal® wingback elbows

Kontrolní box Pexal® pro nástěnku

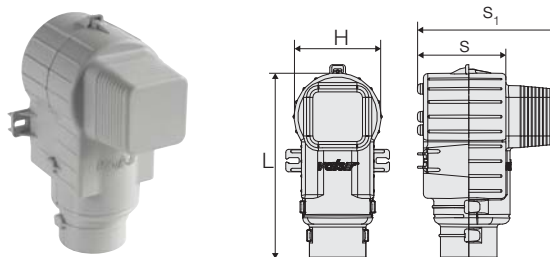

COD.	De (tubo)	L	H	s	s ₁		CL	Kč/ks
VS0104555	14-16-18-20	125	58	59,5	94,5	20	RMP1	661,00

Made of grey polypropylene for the installation of terminal fittings for connection to fixtures of the Pexal® system. The compact size allows for installation in any position. It is made of two shells that allow an easy and rapid introduction of the multilayer pipe with corrugated conduit. The box has holes on the side for fixing it to the wall using plugs and screws (not supplied). The upper shell incorporates a covering that works as protection during plastering and houses a system testing plug. A kit is included with five M 3.5x10 mm screws, for securing the wingback elbows COD. VS0131503, VS0171005, VS0171007, VS0176017, VS0171021, VS0171025, VS0171027, VS0171035.

Vyrobeno ze šedého polypropylenu, pro instalaci finálních armatur uživatelům systému Pexal®.

Malá velikost umožňuje instalaci v jakékoli poloze. Skládá se ze 2 poloskořepin, takže vícevrstvé kompozitní potrubí s vlnitým pláštěm lze snadno a rychle zavést. Krabice má po stranách štěrbinu pro připevnění ke zdi pomocí hmoždinek a šroubů (nejsou součástí dodávky). Horní polovina plast. krytu je opatřena víkem pro ochranu před omítkou a umožňuje umístění nástěnky. Balení obsahuje 5 šroubů M 3,5 x 10 mm, k upevnění přípojovací konzoly ART. - NR. VS0131503, VS0171005, VS0171007, VS0176017, VS0171021, VS0171025, VS0171027, VS0171035.

Terminal fitting

Nástěnkové koleno

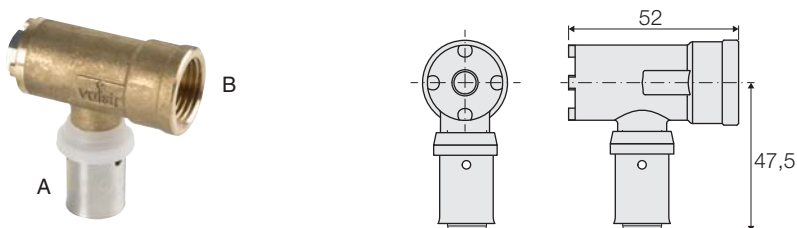

COD.	A		B (inch)		CL	Kč/ks
VS0171061	16x2	H,TH,U	1/2"	10	RMP1	275,00
VS0171063	20x2	H,TH,U	1/2"	10	RMP1	299,00

Can be used with fixing plate with code – Vhodné s montážní deskou ART. - NR. VS 0106005.

Elbow fitting 15° female

Průchozí koleno 15° pro montáž na desku

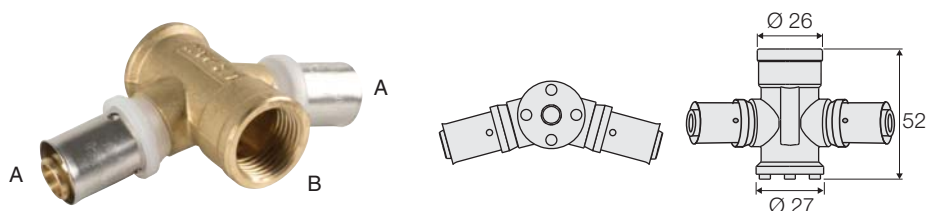

COD.	A		B (inch)		CL	Kč/ks
VS0171071	16x2	H,TH,U	1/2"	5	RMP1	746,00
VS0171073	20x2	H,TH,U	1/2"	5	RMP1	789,00

Can be used with fixing plate with code – Vhodné s montážní deskou ART. - NR. VS 0106005.

PEXAL BRASS FITTINGS RANGE
SORTIMENT PEXAL MOSAZNÉ LISOVANÉ TVAROVKY

Fixing plate for terminal fitting

Montážní spojovací deska, rovná

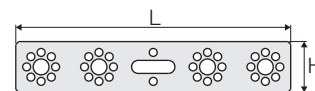

COD.	L	H		CL	Kč/ks
VS0106005	190	35	10	RX00	74,00

2-way manifold

2 cestný mosazný rozdělovač

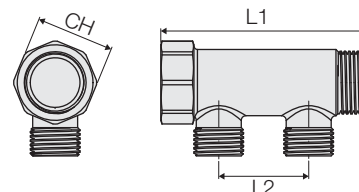
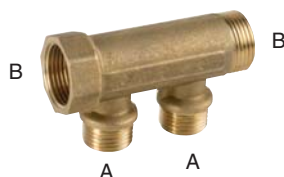

COD.	A (inch)	B (inch)	Outputs Výstupy	L1	L2	CH		CL	Kč/ks
VS0132401	1/2"	3/4"	2	87	38	33	5	RXP1	302,00
VS0132413	3/4"	1"	2	87	38	33	5	RXP1	441,00

To be used with the straight terminal with female nut with 1/2" conic end. – Pro použití s rozdělovačem s připojením 1/2", kónický.

3-way manifold

3 cestný mosazný rozdělovač

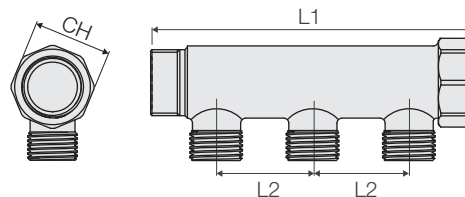
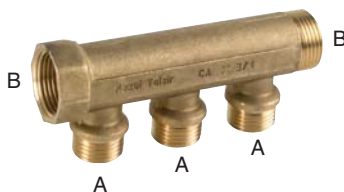

COD.	A (inch)	B (inch)	Outputs Výstupy	L1	L2	CH		CL	Kč/ks
VS0132501	1/2"	3/4"	3	127	38	33	5	RXP1	446,00
VS0132513	3/4"	1"	3	127	38	33	5	RXP1	650,00

To be used with the straight terminal with female nut with 1/2" conic end. – Pro použití s rozdělovačem s připojením 1/2", kónický.

2-way nickel-plated manifold with stop valves

Poniklovaný 2 cestný rozvaděč s uzavíracími ventily

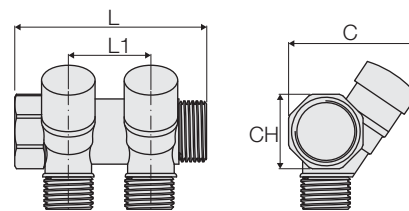

COD.	A (inch)	B (inch)	Outputs Výstupy	Colour Barva ventilů	L	L1	C	CH		CL	Kč/ks
VS0132601	1/2"	3/4"	2	blue – modrá	82,5	35,5	53	32	5	RXP1	578,00
VS0132605	1/2"	3/4"	2	red – červená	82,5	35,5	53	32	5	RXP1	578,00

To be used with the straight terminal with female nut with 1/2" conic end. – Pro použití s rozdělovačem s připojením 1/2", kónický.

3-way nickel-plated manifold with stop valves

Poniklovaný 3 cestný rozvaděč se uzavíracími ventily

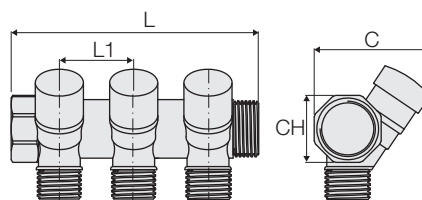
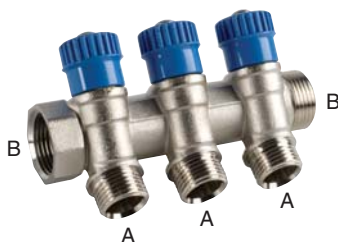

COD.	A (inch)	B (inch)	Outputs Výstupy	Colour Barva ventilů	L	L1	C	CH		CL	Kč/ks
VS0132701	1/2"	3/4"	3	blue – modrá	120	35,5	53	32	5	RXP1	859,00
VS0132705	1/2"	3/4"	3	red – červená	120	35,5	53	32	5	RXP1	859,00

To be used with the straight terminal with female nut with 1/2" conic end. – Pro použití s rozdělovačem s připojením 1/2", kónický.

4-way nickel-plated manifold with stop valves

Poniklovaný 4 cestný rozvaděč s uzavíracími ventily

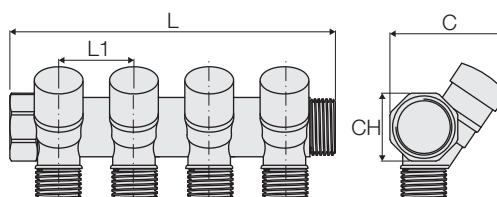

COD.	A (inch)	B (inch)	Outputs Výstupy	Colour Barva ventilů	L	L1	C	CH		CL	Kč/ks
VS0132771	1/2"	3/4"	4	blue – modrá	153,5	35,5	53	32	5	RXP1	1229,00
VS0132775	1/2"	3/4"	4	red – červená	153,5	35,5	53	32	5	RXP1	1229,00

To be used with the straight terminal with female nut with 1/2" conic end. – Pro použití s rozdělovačem s připojením 1/2", kónický.

Spare parts – Náhradní díly

Plastic knobs for manifold

Plastová hlavice ventilu



COD.	Colour - Barva		CL	Kč/ks
VS0102666	blue – modrá	10	RX00	30,00
VS0102667	red – červená	10	RX00	30,00

Screw for manifold with stop valves

Uzavírací ventil - tělo



COD.		CL	Kč/ks
VS0110131	10	RX00	210,00

Accessories – Náhradní díly

Pair of brackets for manifold

Zátka k rozdělovači



COD.	Thread – Závit		CL	Kč/ks
VS0103004	3/4"	10	RX00	104,00

Pair of brackets for manifold

Držák rozdělovače



COD.		CL	Kč/ks
VS0102801	5 pairs – 5 párů	RX00	1371,00

Pair of brackets for painted iron cabinet. – Pro instalaci do rozvodné skříně.

Swivel adaptor for manifolds with 1/2" conic end for manifolds

Pro montáž rozvaděče s připojením 1/2", kónická

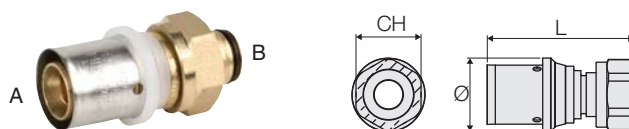

COD.	A		B (inch)	L	Ø	CH			CL	Kč/ks
VS0131601	14x2	H	1/2"	57	20	21	10	200	RXP1	343,00
VS0171105	16x2	H,TH,U	1/2"	57	23	24	10	130	RMP1	314,00
VS0171108	16x2,25	H,TH,U	1/2"	57	23	24	10	130	RMP1	314,00
VS0171115	20x2	H,TH,U	1/2"	54,5	27	24	10	120	RMP1	403,00
VS0171118	20x2,5	H,TH,U	1/2"	57	27	24	10	120	RMP1	403,00

Fitting with seal O-ring and 1/2" cone. – Konektor s O-kroužkovým těsněním a kuželem do 1/2".

For 2, 3, 4-way manifolds with and without shutoff valves codes – Pro 2-3-4cestné rozvaděče s uzavíracími ventily a bez nich ART. - NR. VS0132XXX.

Kit with nut, ogive and tail for manifolds with 1/2" conic end

Konická spojka pro napojení trubek do rozdělovačů



COD.	A (inch)	B	Type – Typ		CL	Kč/ks
VS0101801	1/2"	14x2	A	25	RXA1	104,00
VS0102251	1/2"	16x2	LGR	10	RXA2	132,00
VS0102255	1/2"	16x2,25	A	10	RXA1	130,00
VS0102253	3/4"	20x2	LGR	10	RXA2	149,00
VS0102257	3/4"	20x2,5	A	10	RXA1	148,00

For 2, 3, 4-way manifolds with and without shutoff valves codes – Pro 2-3-4 cestné rozdělovače s uzavíracími ventily a bez nich ART. - NR. VS0132XXX.

Repair fitting

Teleskopická tvarovka pro opravy

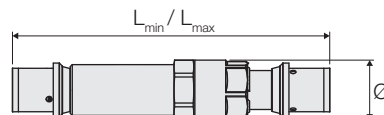

COD.	A	⊙OA	B	⊙OB	L _{min}	L _{max}	Ø			CL	Kč/ks
VS0171205	16x2	H,TH,U	16x2	H,TH,U	150	203,5	25	5	35	RMP1	1326,00
VS0176207	16x2,25	H,TH,U	16x2,25	H,TH,U	145	198,5	25	5	35	RMP1	1326,00
VS0176209	18x2	H,TH,U	18x2	H,TH,U	161	220	30	5	-	RMP1	1437,00
VS0171211	20x2	H,TH,U	20x2	H,TH,U	159	219,5	30	5	25	RMP1	1437,00
VS0171213	20x2,5	H,TH,U	20x2,5	H,TH,U	161	220	30	5	25	RMP1	1437,00
VS0171215	26x3	H,TH,C	26x3	H,TH,C	182	245,5	38	5	15	RMP1	1795,00

Copper transition crimp fitting

Přechodka mezi Cu lisovanou x ALPEX, PEX

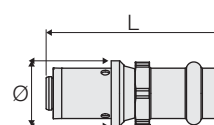

COD.	A	⊙OA	B	⊙OB	L	Ø		CL	Kč/ks
VS0176303	16x2	H,TH,U	14	V	51	23	10	RMP1	256,00
VS0171311	16x2	H,TH,U	15	M,V	62,5	23	10	RMP1	259,00
VS0176305	16x2	H,TH,U	16	V	51	23	10	RMP1	259,00
VS0171312	20x2	H,TH,U	22	M,V	62	27	10	RMP1	295,00
VS0171313	26x3	H,TH,C	22	M,V	64	33	10	RMP1	359,00
VS0171314	26x3	H,TH,C	28	M,V	65	33	10	RMP1	413,00
VS0171315	32x3	VAL,H,TH,U	28	M,V	70	39	5	RMP1	530,00

A = Multilayer/Pex pipe side. Press joint. – [Napojení na AL-PEX, PEX.](#)

B = Copper side. Press joint. – [Napojení na CU systém lisovaný.](#)

Copper transition compression fitting

Přechodka na CU mech. spojka x ALPEX, PEX

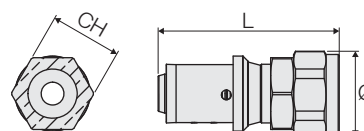

COD.	A	⊙OA	B	L	Ø	CH		CL	Kč/ks
VS0171321	16x2	H,TH,U	15	56	26	22	10	RMP1	302,00
VS0171323	20x2	H,TH,U	22	54	34	30	10	RMP1	465,00
VS0171322	20x2	H,TH,U	18	52	28	24	10	RMP1	415,00
VS0171324	26x3	H,TH,U	22	53,5	36	31	10	RMP1	580,00

A = Multilayer/Pex pipe side. Press joint. – [Přechod na AL-PEX, PEX.](#)

B = Copper side. Compression joint. – [Cu přechod mechanický.](#)

PEXAL BRASS FITTINGS RANGE
SORTIMENT PEXAL MOSAZNÉ LISOVANÉ TVAROVKY

Elbow fitting for connection to copper

Kolenový přechod 90°, z mědi na AL-PEX, PEX

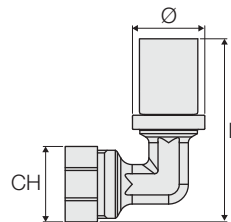

COD.	A		B	L	Ø	CH		CL	Kč/ks
VS0139025	16x2	H,TH,U	15	56,5	22	22	10	RMP1	415,00
VS0139027	20x2	H,TH,U	22	66	26	30	10	RMP1	677,00

A = Multilayer/Pex pipe side. Press joint. – Přechod na AL-PEX, PEX.

B = Copper side. Compression joint. – Cu přechod mechanický.

Elbow fitting with extension in chrome plated copper

Koleno s chrom trubičkou

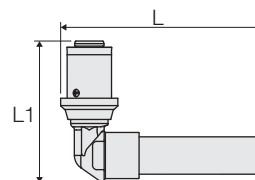

COD.	A		B	L	L1		CL	Kč/ks
VS0171371	16x2	H,TH,U	15	81,5	57	2	RMP1	609,00

Connection fitting for radiators. – Připojení radiátorových těles.

Fitting with bend in chrome plated copper

Obloukové dopojení s chrom trubičkou

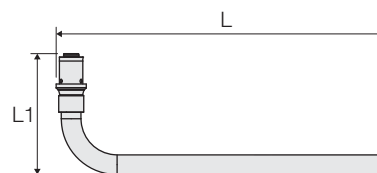

COD.	A		B	L	L1		CL	Kč/ks
VS0171373	16x2	H,TH,U	15	311,5	92	2	RMP1	803,00

Connection fitting for radiators. – Připojení radiátorových těles.

Straight fitting with extension in chrome plated copper

Přímý spoj pro radiátoré dopojení

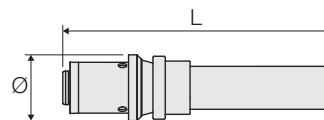

COD.	A		B	L	Ø		CL	Kč/ks
VS0171375	16x2	H,TH,U	15	94	23	2	RMP1	510,00
VS0171377	20x2	H,TH,U	22	92	27	2	RMP1	550,00
VS0171379	26x3	H,TH,C	22	94,5	33	2	RMP1	644,00
VS0171381	26x3	H,TH,C	28	94,5	33	2	RMP1	886,00
VS0171383	32x3	VAL,H,TH,U	28	99,5	39	2	RMP1	981,00

Connection fitting for radiators. – Připojení radiátorových těles.

Transition fitting for Pex pipe

Přechodka Pex-AL-PEX

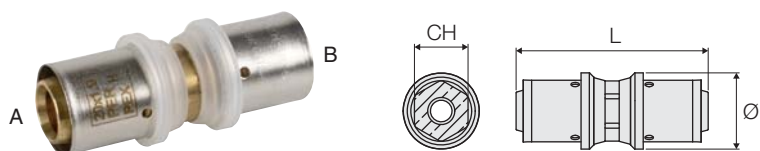

COD.	A	OA	B	OB	L	Ø	CH			CL	Kč/ks
VS0176351	16x2	H	16x1,5	H	50	23	-	10	200	RMP1	199,00
VS0171353	20x2	H	20x1,9	H	63	27	19	10	140	RMP1	212,00

A = Multilayer/Pex pipe side. – Přechodka PEX, ALPEX.

B = Pex side – Přechodka PEX

Stop valve

Uzavírací ventil

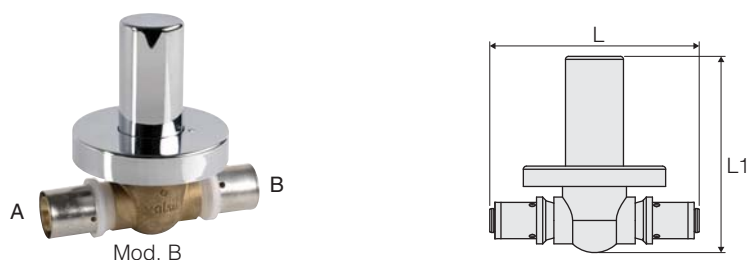

COD.	Mod.	A	OA	B	OB	L	L1		CL	Kč/ks
VS0171406	B	16x2	H,TH,U	16x2	H,TH,U	103	97	5	RMP1	1312,00
VS0171408	B	16x2,25	H,TH,U	16x2,25	H,TH,U	103	97	5	RMP1	1312,00
VS0171414	B	20x2	H,TH,U	20x2	H,TH,U	100	100	5	RMP1	1326,00
VS0171416	B	20x2,5	H,TH,U	20x2,5	H,TH,U	100	100	5	RMP1	1326,00

The isolating service valves have chrome protection. – Uzavírací ventil kompletní s ochranným víčkem z chromu.

Spare parts – Náhradní díly

Chrome plated plug for in-wall valve

Náhradní díly k uzavíracím ventilům



COD.	Mod.		CL	Kč/ks
VS0107151 *	A	1	RX00	236,00
VS0107152 **	B	1	RX00	236,00

* For codes – Pro kody ART. - NR. VS0171405-VS0171407-VS0171413-VS 0171415.

** For codes – Pro kody ART. - NR. VS0171406 -VS0171408 -VS0171414 -VS 0171416.

Spare parts – Náhradní díly

Chrome plated lever
for in-wall valve

Uzavírací ventil s pákou

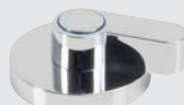

Mod. A



Mod. B

COD.	Mod.		CL	Kč/ks
VS0107153 *	A	1	RX00	597,00
VS0107154 **	B	1	RX00	595,00

* For codes – Kody ART. - NR. VS0171405-VS0171407-VS0171413-VS0171415.

** For codes – Kody ART. - NR. VS0171406 -VS0171408 -VS0171414 -VS 0171416.

Chrome plated knob
for in-wall valve

Hlavice k uzavíracímu ventilu



Mod. A



Mod. B

COD.	Mod.		CL	Kč/ks
VS0107155 *	A	1	RX00	489,00
VS0107156 **	B	1	RX00	489,00

* For codes – Kody ART. - NR. VS0171405-VS0171407-VS0171413-VS0171415.

** For codes – Kody ART. - NR. VS0171406 -VS0171408 -VS0171414 -VS 0171416.

Accessories – Náhradní díly

Chrome plated extension
for in-wall ball valve

Sada nástěnných nástaveb



Mod. A



Mod. B

COD.	Mod.	D		CL	Kč/ks
VS0107257 *	A	16/20	5	RX00	354,00
VS0107256 **	B	16/20	5	RX00	576,00

* For codes – Kod ART. - NR. VS0171405-VS0171407-VS0171413-VS0171415.

** For codes – Kod ART. - NR. VS0171406 -VS0171408 -VS0171414 -VS0171416.

Extension for in-wall ball
valve (with screws and
extended screw)

Prodloužení uzavírací ventil



Mod. A

COD.	Mod.	D		CL	Kč/ks
VS0107255 *	A	16/20	5	RX00	271,00

* For codes – Kod ART. - NR. VS0171405-VS0171407-VS0171413-VS0171415.

Accessories – Náhradní díly

Adapter for valve connection

Adaptér pro připojení ventilu



COD.	Thread – Rozměr		CL	Kč/ks
VS0107501	14	10	RX00	64,00
VS0107503	16x14	10	RX00	50,00
VS0107505	16	10	RX00	50,00

Plastic fixing ring for fittings from D 16 to

D 32 Plastové fixační kroužek pro tvarové díly od D 16 do D 32



COD.	Dxs		CL	Kč/ks
VS0133517	16x2 - 16x2,25	50	RMP1	9,00
VS0133519	18x2	50	RMP1	9,00
VS0133521	20x2 - 20x2,5	50	RMP1	9,00
VS0133527	25x2,5 - 26x3	50	RMP1	10,00
VS0133533	32x3	50	RMP1	11,00

Sleeves for fittings from D 14 to D 32

Náhradní prstenec pro tvarovky D 14 do D 32



COD.	Dxs		CL	Kč/ks
VS0143015 *	14x2	10	RXP1	71,00
VS0143017 *	16x2 - 16x2,25	10	RMP1	72,00
VS0143016 **	16x2 - 16x2,25	10	RMP1	72,00
VS0143018 *	18x2	10	RMP1	83,00
VS0143019 **	18x2	10	RMP1	83,00
VS0143020 *	20x2 - 20x2,25 - 20x2,5	10	RMP1	83,00
VS0143021 **	20x2 - 20x2,5	10	RMP1	83,00
VS0143025 *	25x2,5	10	RMP1	130,00
VS0143026 *	26x3	10	RMP1	130,00
VS0143028 **	26x3	10	RMP1	130,00
VS0143032 *	32x3	10	RMP1	166,00
VS0143033 **	32x3	10	RMP1	166,00

* Sleeve with blocking hooks on fittings with brass fixing ring. – Objímka s aretační sponou na odlitku s mosazným kroužkem.

**Sleeve with blocking hooks on fittings with plastic fixing ring. – Objímka z nerezové oceli s aretační sponou na lisované části s plastovým kroužkem.

O-rings for fittings from D 14 to D 32

O-kroužek pro tvarovky od D 14 do D 32



COD.	Dxs		CL	Kč/ks
VS0133114 *	14x2	50	RXP1	5,00
VS0133115 *	16x2	50	RMP1	6,00
VS0133119 **	16x2	50	RMP1	6,00
VS0133117 ***	16x2,25	50	RMP1	6,00
VS0143118 *	18x2	50	RMP1	6,00
VS0133118 ***	20x2 - 20x2,25 - 20x2,5	50	RMP1	6,00
VS0133121 **	20x2	50	RMP1	6,00
VS0133126 *	25x2,5 - 26x3	50	RMP1	7,00
VS0133128 **	25x2,5 - 26x3	50	RMP1	7,00
VS0117226 *	32x3	50	RMP1	8,00
VS0133133 **	32x3	50	RMP1	8,00

* For fittings with brass fixing ring. – Pro lisované díly s mosazným upevňovacím kroužkem.

** For fittings with plastic fixing ring. – Pro lisované díly s plastovým upevňovacím kroužkem.

*** For fittings with brass and plastic fixing ring. – Pro lisované díly s upevňovacím kroužkem z mosazi a plastu.

Plastic seal base for fitting from D 14 to D 32

Plastové těsnění od D 14 až D 32



COD.	Dxs		CL	Kč/ks
VS0133214	14x2	50	RXP1	7,00
VS0133516	16x2 - 16x2,25	50	RMP1	7,00
VS0133518	18x2	50	RMP1	8,00
VS0133520	20x2 - 20x2,25 - 20x2,5	50	RMP1	8,00
VS0133526	25x2,5 - 26x3	50	RMP1	9,00
VS0133532	32x3	50	RMP1	11,00

Plastic seal base for fittings with brass ring. – Plastové těsnění pro tvarovky s mosazným upevňovacím kroužkem.

Plastic seal base for fitting from D 40 to D 90

Plastový fixační kroužek od D 40 do D 90



COD.	Dxs		CL	Kč/ks
VS0133540 *	40x3,5	50	RXP3	14,00
VS0133541 **	40x3,5	50	RXP3	14,00
VS0133550 *	50x4	50	RXP3	15,00
VS0133551 **	50x4	50	RXP3	15,00
VS0133563 *	63x4,5	50	RXP3	21,00
VS0133565 **	63x4,5	50	RXP3	21,00
VS0133575 *	75x5	20	RXP3	66,00
VS0133576 **	75x5	20	RXP3	66,00
VS0133590 *	90x7	20	RXP3	93,00

* For fittings with removable sleeve. – Pro lisované díly s odnímatelným pouzdrem z nerezové oceli.

** For fittings with non-removable sleeve. – Pro tvarové díly s neodnímatelným pouzdrem z nerezové oceli.

Sleeves for fittings from D 40 to D 90

nerezový kroužek od D 40 do D 90



COD.	Dxs		CL	Kč/ks
VS0143041 **	40x3,5	10	RXP3	258,00
VS0143050	50x4	10	RXP3	335,00
VS0143063	63x4,5	10	RXP3	515,00
VS0143075	75x5	5	RXP3	804,00
VS0143090	90x7	1	RXP3	1280,00

** For fittings with non-removable sleeve. – Pro lisované díly s neodnímatelným pouzdrem z nerezové oceli.

O-rings for fittings from D 40 to D 90

O-kroužek těsnění od D 40 do D 90



COD.	Dxs		CL	Kč/ks
VS0133140	40x3,5	50	RXP3	11,00
VS0133150	50x4	50	RXP3	14,00
VS0133163	63x4,5	50	RXP3	22,00
VS0133175	75x5	50	RXP3	27,00
VS0133190	90x7	20	RXP3	39,00

PEXAL CONNEX-T

Derivation clamp for multilayer systems

Univerzální příslušenství – navrtávka s vnějším závitem, pro vícevrstvé kompozitní trubky



COD.	D pipe – Trubka	D ₁		CL	Kč/ks
VS0108151	50	½" M	5	RX00	1622,00
VS0108153	63	¾" M	5	RX00	2912,00
VS0108155	75	¾" M	2	RX00	4482,00
VS0108157	75	1" M	2	RX00	4988,00
VS0108159	90	1" M	2	RX00	9089,00

To be used with hole saw item number. – K vyvrtání otvoru je nutné použít frézy s dutou stěnou. ART. - NR. VS0108111-VS0108113-VS0108115.

Spare parts – Náhradní díly

Kit screws and lock nuts

Sada se šrouby a pojistné matice



COD.		CL	Kč/ks
VS0108121	1 (6 pz)	RX00	74,00

Screws and lock nuts kit for locking Connex-T parts. – Sada se šrouby a pojistnými maticemi pro upevnění pouzder Connex-T.

Seal

těsnění



COD.	D		CL	Kč/ks
VS0108123	½"	5	RX00	73,00
VS0108124	¾"	5	RX00	81,00
VS0108125	1"	5	RX00	97,00

Hole saw

Speciální vrták pro otvor do potrubí



COD.	D Hole saw - Fréza	D Pipe – Trubka	D Derivation - Odbočka		CL	Kč/ks
VS0108111	½"	50	½"	1	ATPX	1338,00
VS0108113	¾"	63-75	¾"	1	ATPX	1663,00
VS0108115	1"	75-90	1"	1	ATPX	2245,00

Hole saw to make the derivation hole on the multilayer pipe for the Connex-T system. The package includes a roll of sandpaper to smooth the hole. – Fréza pro vrtání odbočky do vícevrstvé kompozitní trubky pro systém Connex-T. Balení obsahuje roli brusného papíru pro broušení ohrotů.